

T3DSO2000 Digital Oscilloscope Quick Start Guide

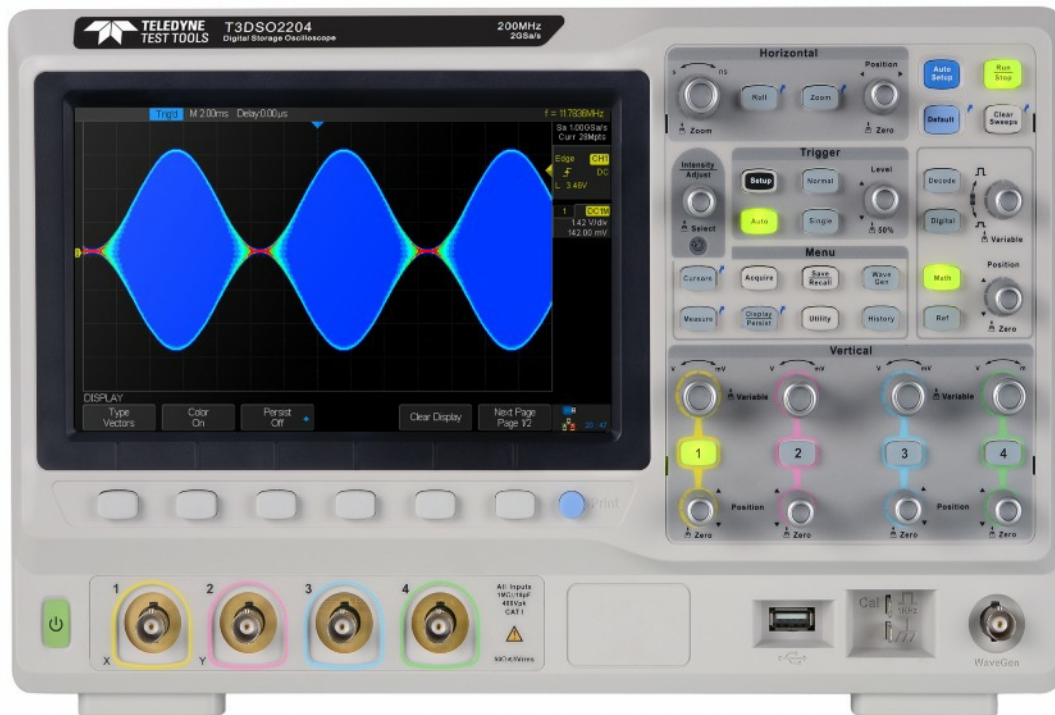

Version 1.1
September, 2018

© 2018 Teledyne LeCroy, Inc. All rights reserved.

Teledyne Test Tools is a brand and trademark of Teledyne LeCroy, Inc. Other product or brand names are trademarks or requested trademarks of their respective holders. Specifications, prices, availability and delivery subject to change without notice.

Contents

General Safety Summary	2
Daily Maintenance and Cleaning	4
General Inspection	5
Size and Adjustments	6
Connecting to AC Power	7
Connecting and Compensating Probes	7
Front and Rear Panel Overview	9
Front Panel Operation	11
Display Overview	18
Kensington Lock Point	20
Troubleshooting	20

General Safety Summary

Read the following precautions carefully to avoid any personal injuries, or damage to the instrument or products connected to it. Use the instrument only as specified.

Use only the power cord supplied for the instrument.

Ground the instrument. The instrument is grounded through the ground conductor of the power cord. To avoid electric shock, always connect to grounded outlets. Make sure the instrument is grounded correctly before connecting its input or output terminals.

Connect the signal wire correctly. To avoid damage, observe input polarity and maximum voltage/current ratings at all times.

Observe all terminal ratings and signs on the instrument to avoid fire or electric shock. Before connecting to the instrument, read the manual to understand the input/output ratings.

Do not operate with suspected failures. If you suspect that the instrument is damaged, contact the Teledyne LeCroy service department immediately.

Do not operate in wet/damp conditions.

Do not operate in an explosive atmosphere.

Keep the surface of the instrument clean and dry.

Avoid touching exposed circuits or wires. Do not touch exposed contacts or components when the power is on.

Do not operate without covers. Do not operate the instrument with covers or panels removed.

Use only the fuse specified for the instrument.

Use proper over voltage protection.

Use anti-static protection. Operate in an anti-static protected area. Ground measurement cable conductors before connecting to the instrument to discharge any static electricity before connecting the cables to the instrument.

Observe ventilation requirements. Ensure good ventilation. Check the vent and fan regularly to prevent overheating.

Safety Terms and Symbols

The following terms may appear on the instrument:

DANGER: Direct injury or hazard may occur.

WARNING: Potential injury or hazard may occur.

CAUTION: Potential damage to instrument/property may occur.

The following symbols may appear on the instrument:



CAUTION
Risk of injury or damage. Refer to manual.



WARNING
Risk of electric shock or burn



Earth
Ground
Terminal



Protective
Conductor
Terminal



Frame or
Chassis
Terminal



ON/
Standby
Power



Alternating
Current

Measuring Terminal Ratings

Max. Input Voltage: $1\text{ M}\Omega \leq 400\text{ Vpk (DC + Peak AC} \leq 10\text{ KHz)}$
 $50\ \Omega \leq 5\text{ Vrms}$

Derated Voltage: $400\text{ Vmax to }10\text{ KHz, derating at }20\text{ dB/decade to }10\text{ Vmax at }400\text{ KHz}$

No rated measurement category per IEC/EN 61010-031:2015.

Measuring terminals on this product are not intended to be connected directly to mains.

Operating Environment

Temperature: $10\text{ }^\circ\text{C to }40\text{ }^\circ\text{C}$

Relative Humidity: $85\%\text{ RH at }40\text{ }^\circ\text{C for up to }24\text{ hours}$

Altitude: $\leq 3000\text{ m}$

Use indoors only.

Pollution Degree 2. Use in an operating environment where normally only dry, non-conductive pollution occurs. Temporary conductivity caused by condensation should be expected.

AC Power

Input Voltage & Frequency: 100-120 V at 400 Hz or
100-240 V at 50/60 Hz

Automatic AC selection.

Power Consumption: 80 W maximum

Mains Supply Connector: CAT II per IEC/EN 61010-1:2015, instrument intended to be supplied from the building wiring at utilization points (socket outlets and similar).

Fuse Type

1.25 A / 250 V "T" rated 5x20 mm

Daily Maintenance and Cleaning

Maintenance

Protect the liquid crystal display from direct sunlight when storing or using the instrument.

NOTE:

To avoid damage to the instrument or test leads, do not place them in mist, liquid or solvent.

Cleaning

Regularly clean the instrument and test leads.

- Wipe the external dust off the instrument and test leads using a damp soft rag. Be careful not to scratch the display screen when cleaning. Do not allow any liquid to enter the instrument.
- Use a 75% isopropyl alcohol/water solution when a more thorough cleaning is necessary.

NOTE:

To prevent damage to the surface of the instrument or test leads, do not use any corrosive or chemical cleaning agents. Make sure the instrument is fully dry before reconnecting the power to avoid short circuiting or personal injury.

General Inspection

Please check the instrument according to the following steps.

1. Inspect the shipping container.

Keep the shipping container and packaging material until the contents of the shipment have been completely checked and the instrument has passed both electrical and mechanical tests. It is always good practice to save the shipping container and packaging for use when returning the power supply to Teledyne LeCroy for service or calibration.

The consigner or carrier will be responsible for damage to the instrument resulting from shipping. Teledyne LeCroy will not provide free maintenance or replacement in this instance.

2. Inspect the instrument.

If the instrument is found to be damaged, defective or fails in electrical or mechanical tests, please contact the Teledyne LeCroy service department immediately.

3. Check the accessories.

Please check that you have received the accessories on the packing list. If the accessories are incomplete or damaged, please contact Teledyne LeCroy immediately.

Size and Adjustments

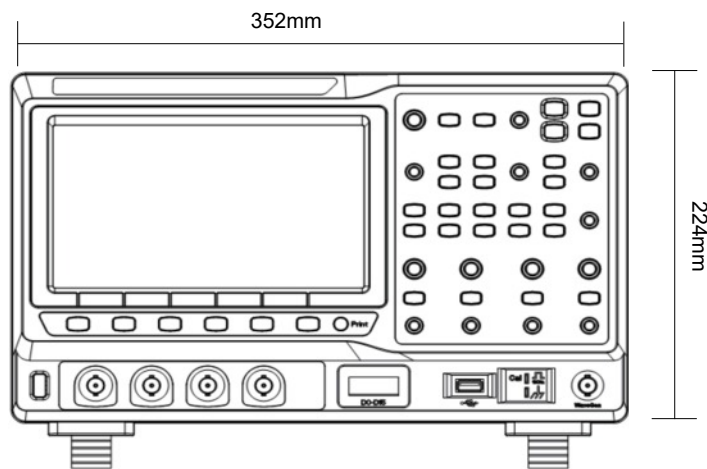

Figure 1 Front View

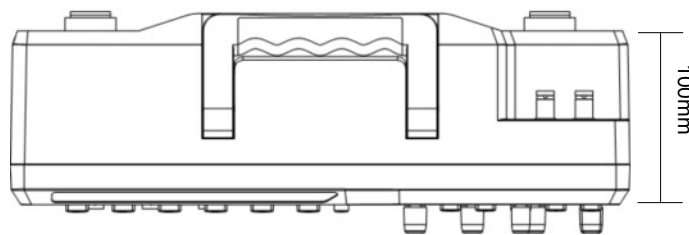
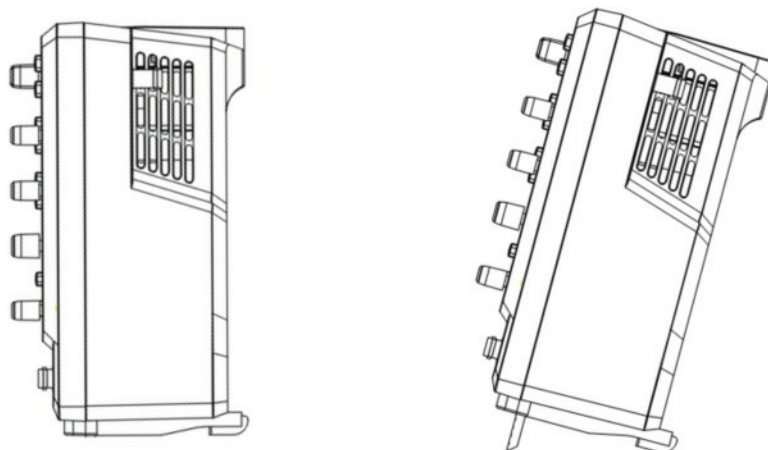

Figure 2 Top View

Adjusting the Supporting Legs

Adjust the supporting legs to adjust the angle / tilt of the oscilloscope for best ease of use. The oscilloscope is stable in flat or tilted mode. The oscilloscope is not stable if one supporting leg is extended and the other is not. Both supporting legs should either be extended or not.



Connecting to AC Power

The oscilloscope accepts 100-240V at 50/60Hz, or 100-120V at 440Hz AC power. Please use the power cord provided to connect the instrument to the power source as shown in the figure

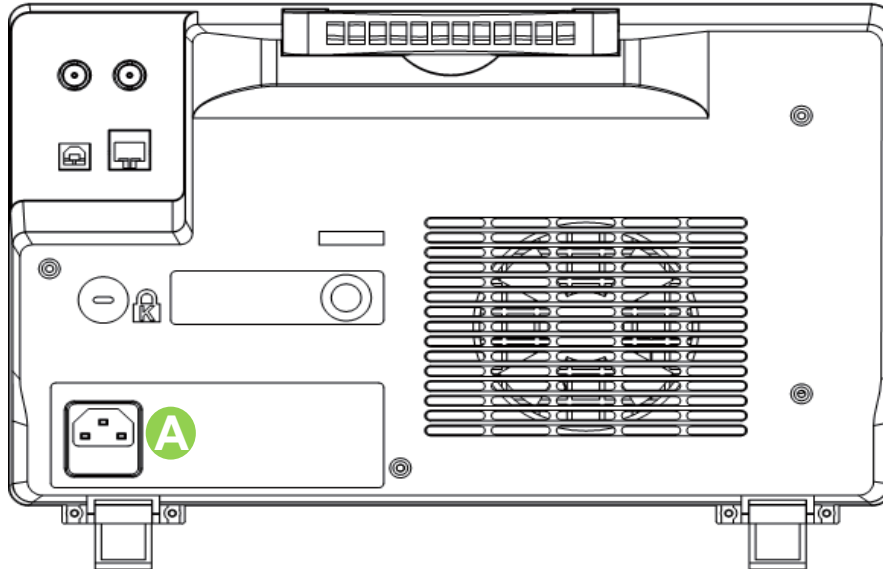

A Connect the power cord to socket A in the diagram above. Note: If at any time the fuse requires replacement, please replace only with a fuse of the same rating as the original. If there are questions, please contact Teledyne LeCroy directly.

Power-on Inspection

Turn on the power switch at the lower left corner on the front panel. During the start-up process, the instrument performs a series of self-tests and the user can hear the sound of relays switching. The User Interface displays immediately after the self-test is complete.



Connecting and Compensating Probes

The Teledyne Test Tools oscilloscope is provided with one passive probe for for each channel (excluding Ext Trigger). Please refer to corresponding Probe User Manual for detailed probe technical information.

Connecting Probes

1. Connect the BNC terminal of the probe to one of the channel BNC connectors on the front panel.
2. Connect the probe tip to the probe compensation signal, to test the probe, and the ground alligator clip of the probe to the ground terminal of the circuit.

Functional Inspection

1. Press  to reset the oscilloscope to its factory default setup.
 2. Connect the probe to CH1. Connect the ground alligator clip of the probe to the Ground Terminal on the front panel.
 3. Connect the probe tip to the Compensation Signal Output Terminal on the front panel.
- ← Compensation Signal Output Terminal
← Ground Terminal
4. Press .
 5. Observe the waveform on the screen. The display should be a square waveform as shown in the screen image below.
 6. Test the other channels using the same method. The displayed waveform should be a square wave as in the screen image below. If the displayed signal does not match the screen image below, then perform a "Probe Compensation".

Note: Please make certain that the insulated wire of the probe is in good condition to avoid electric shock when using the probes, and do not touch the metallic part of the probe when it is connected to a high voltage.

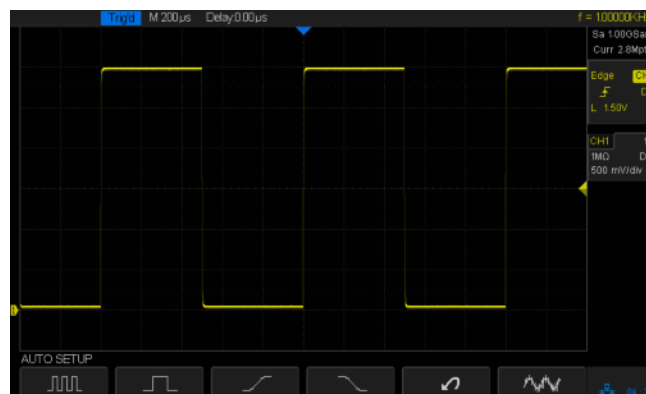

Probe Compensation

The oscilloscope requires proper compensation adjustment to give accurate results. Non-compensated or inadequately compensated probes may give inaccurate measurements. Follow the steps below to adjust the probe compensation:

1. Check the displayed waveforms and compare them with the diagrams below.
2. Use a non-metallic screwdriver to adjust the low-frequency compensation adjustment hole on the probe until the waveform changes to be correctly compensated as in the centre figure below and the screen image above.

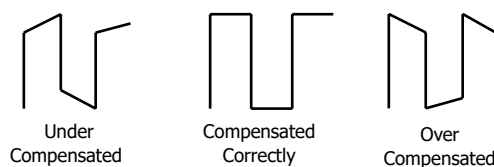

T3DSO2000 Front Panel

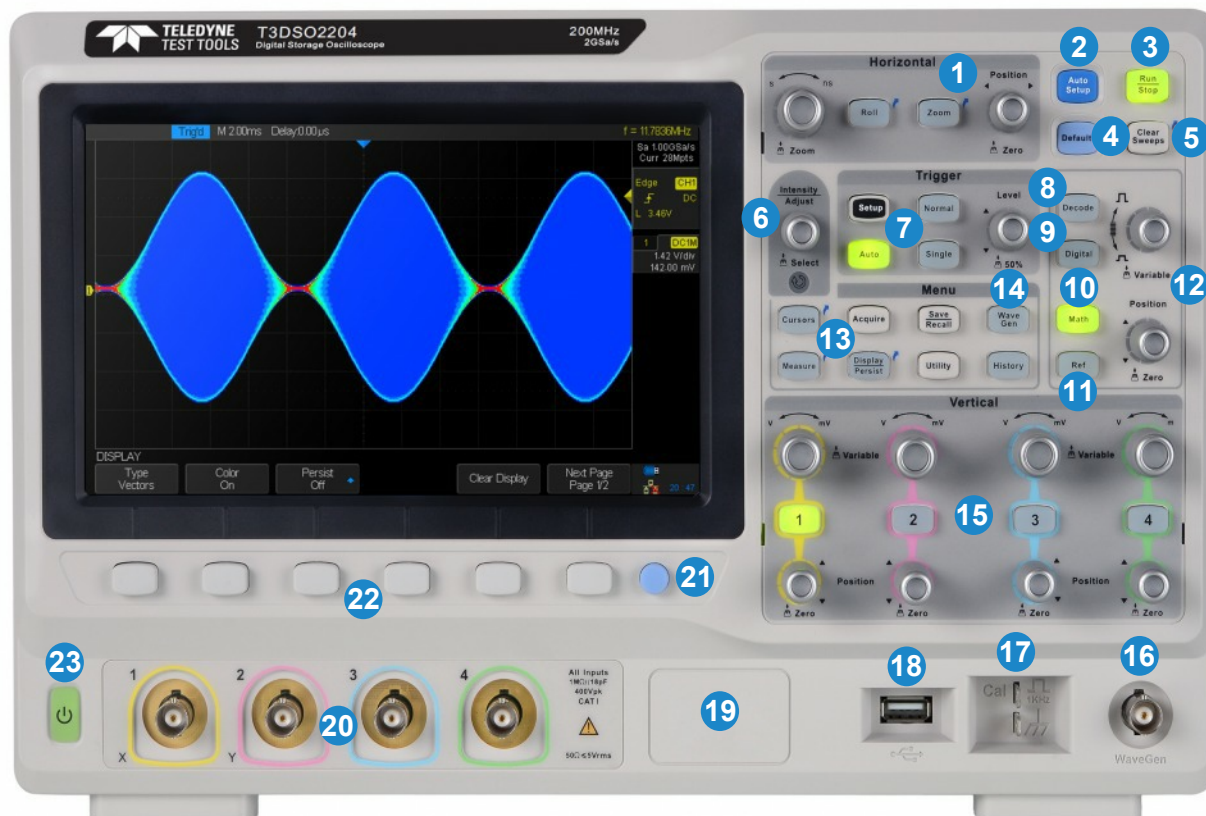

- | | |
|--|--|
| 1. Horizontal Controls | 13. Function Menus |
| 2. Auto Setup | 14. Waveform Generator Menu |
| 3. Run/Stop | 15. Channel Vertical Controls |
| 4. Default Setup | 16. Waveform Generator Output BNC |
| 5. Clear Sweeps | 17. Probe Compensation Connectors |
| 6. Universal Knob | 18. USB Host Port |
| 7. Triggering Controls | 19. Digital Inputs (not shown on this image) |
| 8. Decode | 20. Analog Input BNC Connectors |
| 9. Digital Channels | 21. Configurable Print Button |
| 10. Math | 22. Menu Softkeys |
| 11. Reference | 23. Power On / Off Button |
| 12. Channel Vertical Control, Math,
Reference, Decode and Digital | |

The 2 channel T3DSO2000 series oscilloscopes have only channels 1 and 2 at item 15 above, and only BNC connectors 1 and 2 at item 20 above.

The Digital Lead Set is connected in at item 19 above (not shown on the above image).

T3DSO2000 - Rear Panel

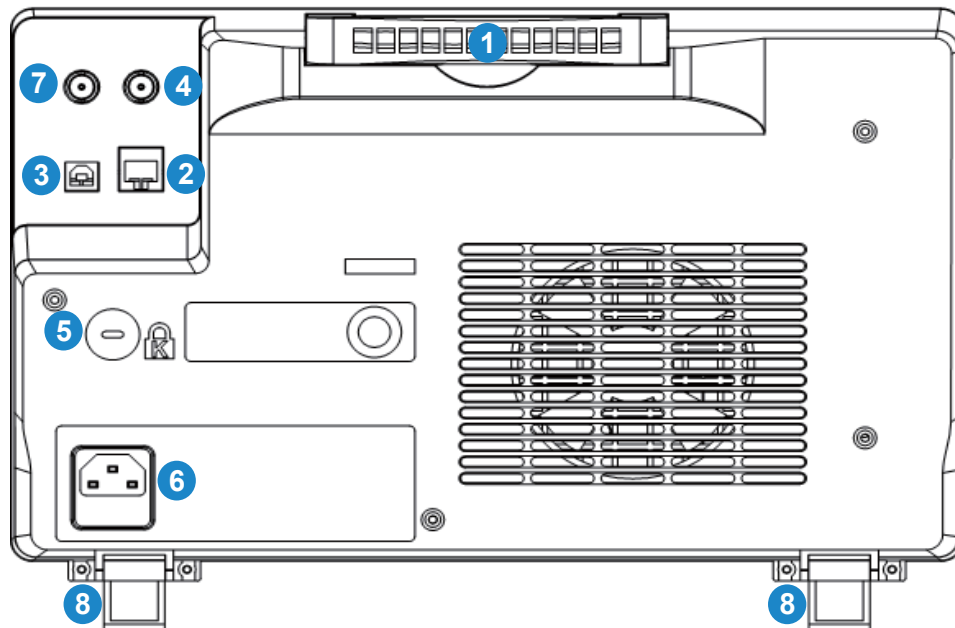

1. Handle

2. LAN Interface

The instrument can be connected to the network via a LAN cable.

3. USBTMC Device

The Teledyne Test Tools T3DSO1000 series oscilloscopes support SCPI remote control commands. User can control the oscilloscope through this interface

4. External Trigger Input Connector

5. Safety Lock Hole

This is a Kensington Lock point to secure your oscilloscope. The Kensington Lock is not supplied with the oscilloscope.

6. AC Power Socket

The power requirements of this oscilloscope are 100-240 V, 50/60/400 Hz. Use the power cord provided with the instrument to connect it to AC power.

7. Pass/Fail or Trig Out Output

The connector can be configured to output a pulse when the oscilloscope triggers or output a pulse on a Pass/Fail condition.

8. Legs

Adjustable supporting legs.

Front Panel Operation

Horizontal Control



Quickly enter into Roll mode. Roll mode updates the screen in a similar manner to that of a strip chart recorder, and is primarily used for low frequency signals. The timebase range for Roll mode is from 50 ms/div to 10 s/div.



Horizontal Position: Adjusts the horizontal time location on the display. Zero time is the trigger point. The waveform will move left or right when the knob is turned. The Delay value will increase or decrease as the waveform moves. Press the knob to reset the trigger delay to zero.



Horizontal Time Base: The timebase is adjusted by turning the knob clockwise or anti-clockwise to increase or decrease the time window being captured on the oscilloscope. The waveform will be expanded or compressed when the timebase is adjusted. Press the knob to Zoom the setting.

Trigger Adjustment



Press the Setup button to open trigger menu. The oscilloscope provides various trigger types: Edge, Slope, Pulse, Video, Window, Interval, DropOut, Runt, Pattern and Serial Bus (IIC / SPI / UART / RS232 / CAN / LIN)



Following is an introduction to Video, Interval, Runt, Pattern and Serial Bus trigger.

HDTV Video Trigger

The T3DSO2000 supports analog video signal (NTSC / PAL) trigger and HDTV signal trigger. In video trigger, you can select custom to set any line and field combination.

Interval Trigger

The time interval from the rising edge (or falling edge) of input signal passes through the trigger level to the next rising edge (or falling edge) passes through the trigger level and the currently set time satisfy the Limit Range ($< =$, $> =$, $[\text{---}]$, $[- \text{---}]$) selected.

In the figure below, the time interval between two continuous rising edge and the currently set time satisfy the limit range ($[\text{---}]$)

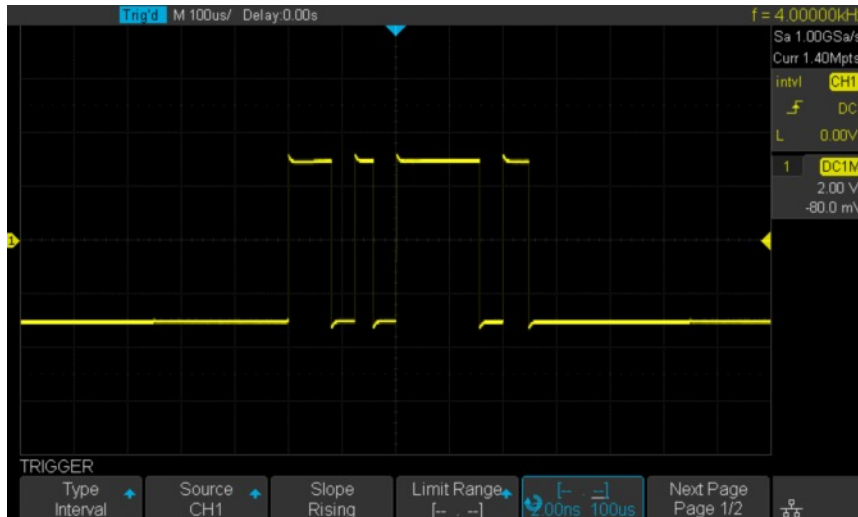

Runt Trigger

Runt trigger includes positive runt trigger and negative runt trigger. This mode is used to trigger pulses that pass through one trigger level but fails to pass through the other trigger level as shown in the figure below.

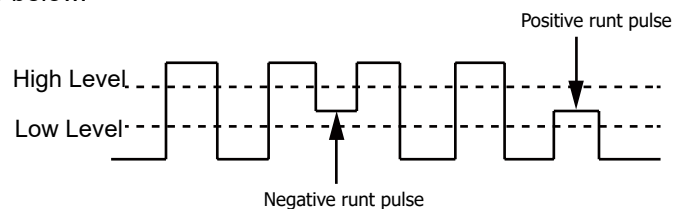

In the figure below, the trigger signal is a positive runt pulse.

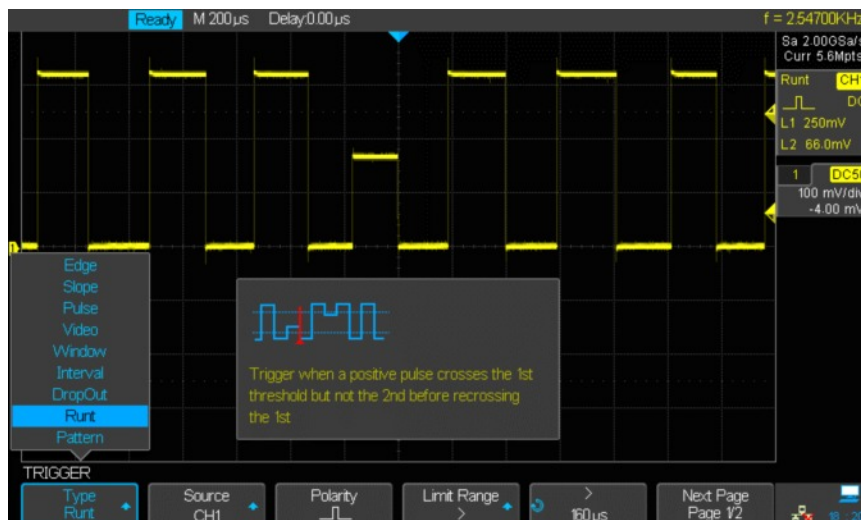

Pattern Trigger

Identify a trigger condition by looking for a specified pattern. This pattern is a logical combination (AND / OR / NAND / NOR) of the channels. Each channel can be set a value of High, Low or Invalid.

In the figure below, the selected logic is “AND”, channel 1 is set to “High”, channel 2 is set to “High” and the “AND” duration is set to > 48.9 us.

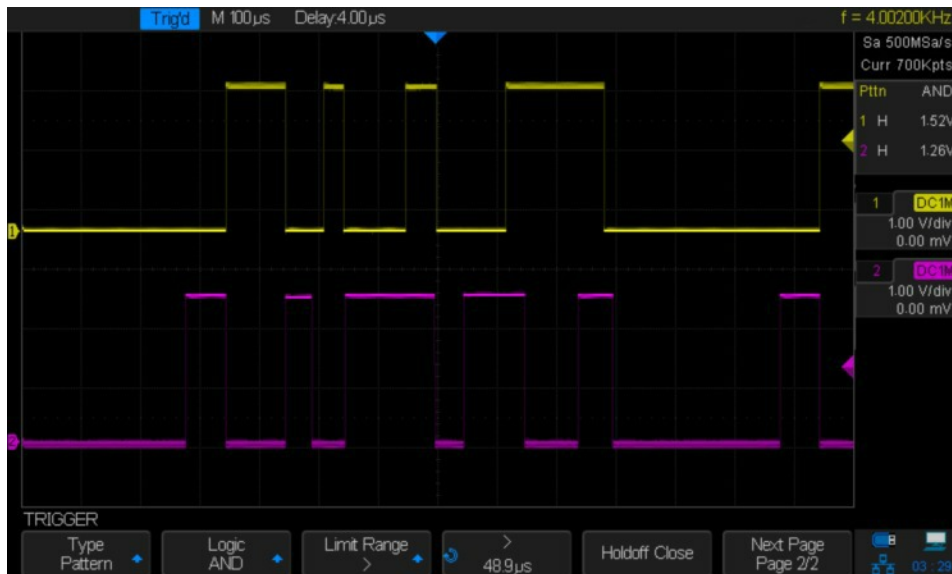

I2C Trigger

Set the serial 1 or 2 to IIC type in trigger menu. Use universal knob to set to trigger on a start/stop condition, restart, no ack, EEPROM, or on the read / write frame with specific device address and data value. During I2C trigger settings, it is essential to set source channel previously in decode menu.

In the figure below, the trigger condition is set to “Start”, channel 1 is set as Clock signal, channel 2 is set as Data signal.

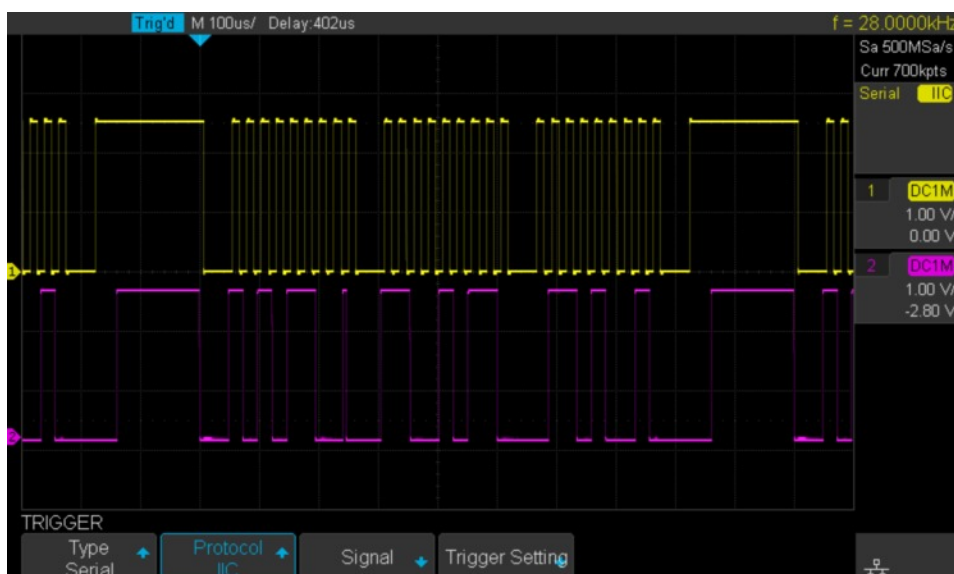

SPI Trigger

After setting the serial trigger to SPI type in trigger menu, you can select to trigger on MISO data or MOSI data. The data length is variable from 4 to 96.

UART/RS232 Trigger

After setting the serial trigger to UART/RS232 type in trigger menu, you can select to trigger on start, stop, checksum error or data. The data width is variable from 5 to 8 bits.

CAN Trigger

After setting the serial trigger to CAN type in trigger menu, you can select to trigger on start, remote, ID, ID+DATA or Error on CAN-H or CAN-L signals.

LIN Trigger

After setting the serial trigger to LIN type in trigger menu, you can select to trigger on Start, ID, ID+DATA or Data Error.

 Press the button to set to Auto trigger mode.

 Press the button to set to Normal trigger mode.

 Press the button to set to Single trigger mode.



Use the Trigger Level knob to set the trigger level. Turn the knob clockwise or anticlockwise to change the level up or down. The trigger level value is displayed at the upper right of the screen and will increase or decrease accordingly. Press the knob to quickly reset the trigger level to the 50% level of the trigger channel waveform.

Vertical Control

The two / four channels are marked by different colors which are also used to mark the waveforms on the screen and the channel input connectors. Press the channel button to open the corresponding channel menu and press again to turn it off.

Vertical Position: Sets the vertical offset / position of the current waveform. Turn clockwise



or anticlockwise to adjust the offset / waveform position.

During the adjustment, the waveform will move up and down and the offset message at the lower part of the screen will change. Press the knob to quickly reset the offset to zero.

Vertical Scale: Sets the vertical scale of the current waveform. Turn clockwise to decrease the



scale and anticlockwise to increase it. During the adjustment, the 'amplitude' of the waveform will

enlarge or reduce and the scale message at the right side of the screen will also change. Press the knob to quickly switch the vertical scale adjustment modes between "Coarse" and "Fine".

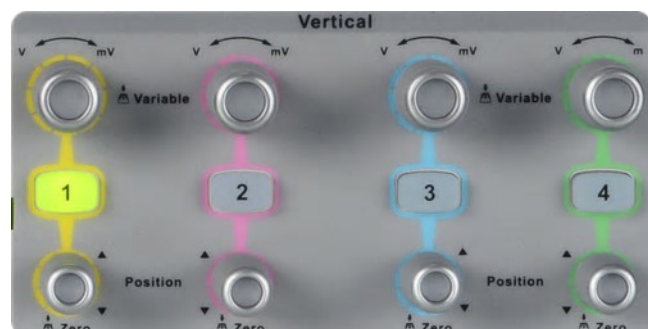



Press the Decode button to open the decode menu. Decode is an optional function. The oscilloscope supports decoding of two serial buses simultaneously. The protocols include I2C, SPI, UART / RS232, CAN and LIN.

The screen image below shows decoding of an I2C signal with a 7 bit address. Data is on Ch1 in yellow, the clock on Ch2 in pink.



Press the Digital button to open the digital channel function menu (Optional function). The T3DSO2000 oscilloscopes supports 16 digital channels with the appropriate options.

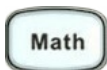

Press the Math button to open math operation menu under which the operation of adding, subtracting, multiplying, dividing, FFT, integral, differential and square root are found.

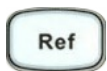

Press the Ref button to enable the reference waveform function, enabling the user to compare the current waveform with the reference waveform. Up to 4 reference waveforms can be stored in the T3DSO2000.

Vertical Scale: Set the vertical scale of the Math or Ref waveform. Turn the knob clockwise or counterclockwise to change the scale accordingly. During the modification, the 'amplitude' of the waveform will increase or decrease and the scale value displayed on the right side of the screen will change accordingly. In addition, the knob can be used to change a digital channel.

Vertical Position: Set the vertical offset of the Math or Ref waveform. Turn clockwise or counterclockwise to set the required offset. During the modification, the waveform will move up and down and the offset message at the lower part of the screen will reflect this change. Press the knob to quickly reset the offset to zero.

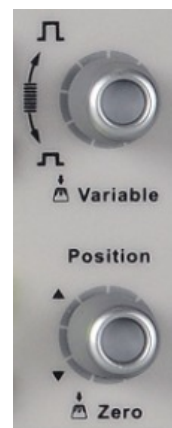

Run Control, Default Setup and Clear Sweeps



Press the Auto Setup button to enable the waveform auto setup function. The oscilloscope will automatically adjust the horizontal time base, vertical scale and trigger mode according to the input signal to provide a triggered stable display if possible. If the waveform is a single event waveform, or very infrequent waveform (such as a low repetitive rate pulse) then the Auto Setup function may not work.

The oscilloscope should be set up manually in these cases.



Press the Run / Stop button to set the state of the instrument to “RUN” or “STOP”. In the “RUN” state, the button glows yellow; In “STOP” state, the button glows red.



Press the Default button to reset the oscilloscope to its default setup. The default voltage scale and timebase scale are 1V/div and 1 μ s/div.



The Clear Sweeps button is a shortcut key for clear function. When measurement statistics are being displayed, press this button to clear the count and begin a new statistical count. When the screen persistence feature is turned on, press this button to clear the persistence.

Adjust Waveform Intensity / Graticule / Transparency



Press the Intensity knob, and use the knob to adjust the waveform intensity (from 0% ~ 100%). The graticule (from 0% ~ 100%) or transparency (from 20% ~ 80%) adjust in the same way as waveform intensity. The Display / Persist button can also be pressed then the Intensity knob used as described above.

Universal Knob

In menu operation, when the light below the knob is lit, you can turn the knob to select between sub-menus under the current menu, and press the knob to select the current sub-menu. In addition, it can also be used to modify parameters and input filenames.



Function Menus



Press the Cursors button to open the cursor function. It provides manual and tracking cursor mode.



Press the Display / Persist button to enter the display menu and quickly enabled the persistence function. Users can set the grid, intensity, graticule and transparency.



Press the History button to enter the history mode. The T3DSO2000 can record up to 80,000 waveforms in history mode, depending on acquisition memory depth used.



Press the Utility button to enter the utility menu. System functions and parameters, such as IO set, sound, language, can be set from this menu. In addition, some advanced functions (such as Pass/Fail, Do Self Cal, install option and Update) are also supported.



Press the Measure button to enter the measurement setting menu. The Measure menu allows the setting of measurement type, statistics function, all measurements and gated measurements. Five measurement parameters can be set. In statistics function, the Current value, Mean, Min, Max, Std-Dev and Count are shown on the screen. Using All Measure, all the parameters of the selected channel are shown.



Press the Acquire button to enter the acquisition menu. You can set the acquisition mode to Normal / Peak-Detect / Average / Eres, interpolation mode (Sinx/X or linear), and memory depth. You can access and enable the XY function and sequence function.



Press the Save / Recall button to enter the file save and recall function menu. The storable file types includes Setups, Waveforms, Picture and CSV.

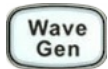

Press the Wave Gen button to open the optional waveform generator menu.

11 types of Waveforms including Sine, Square, Ramp, Pulse, DC, Noise, Cardiac, Gaus Pulse, ExpRise, ExpFall and Arb are supported.

The maximum output frequency is 25MHz (Sine Wave). In addition, the user can download and output up to four different waveforms using external software.

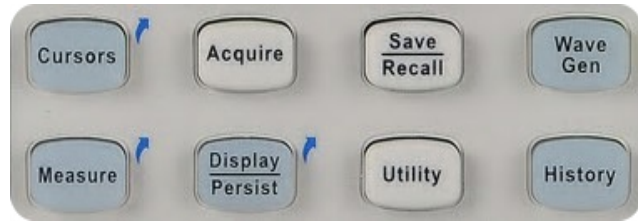

Display Overview

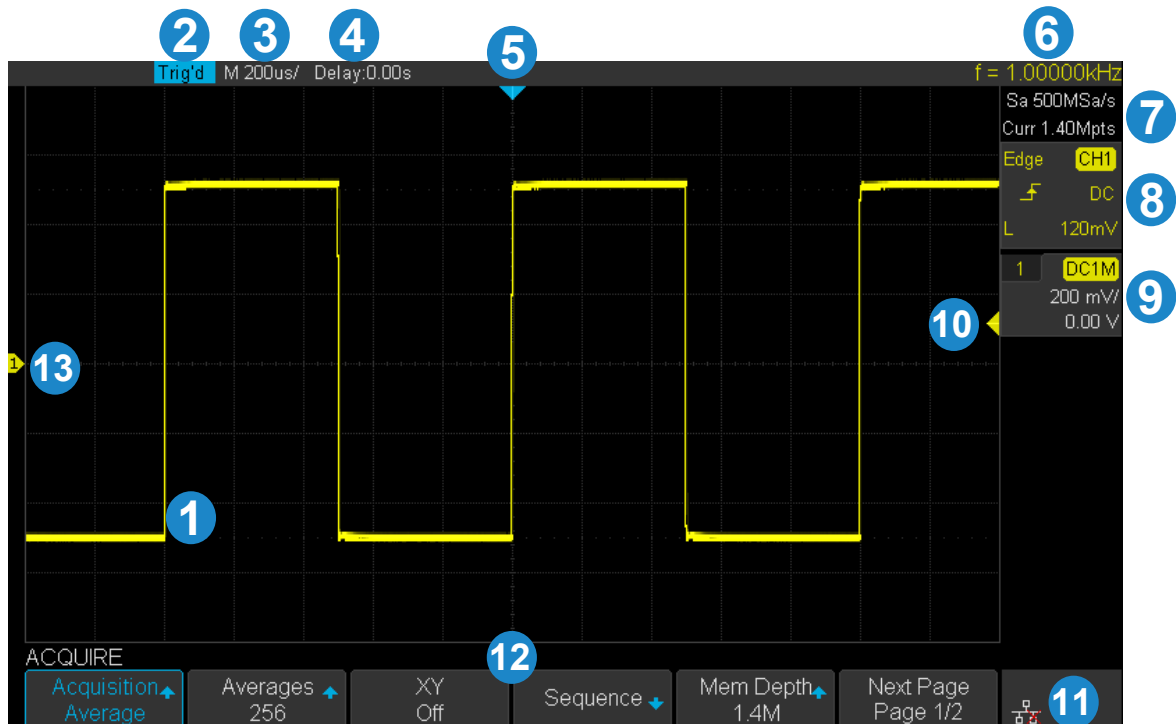

1. Waveform Display Area

Different channels are marked by different colors. The color of the waveform is the same as the color of the channel button and channel BNC connector.

2. Trigger state

Indication of the current trigger state. The possible trigger states are Arm, Ready, Trig'd, Stop, Auto.

3. Horizontal Time Base

The setting of the horizontal time per division. There are 14 divisions across the screen. Total time in the acquisition above is 200 us per division or $14 \times 200 \text{ us} = 2.8 \text{ ms}$ across the screen. The time per division can be adjusted from 2 ns to ~50 s per division.



4. Delay

Use horizontal **POSITION** knob to modify the zero time position on the display and thereby adjust the screen delay. Turn the knob clockwise or counterclockwise to adjust the waveform delay position. This will cause the Delay parameter value to decrease or increase. Press the knob to automatically reset the parameter to zero delay as well as return the waveform to the horizontal centre of the screen.



5. Trigger position

The blue triangle is the zero time indicator, see 4 above. Zero time is the trigger position, therefore the blue triangle also displays the trigger position on the screen.

6. Frequency Counter

Shows the frequency of the displayed waveform.

7. Sample Rate/Memory Depth

Displays the current sample rate and memory depth of the oscilloscope. Use horizontal SCALE knob to modify the parameter.

8. Trigger Setting

Displays the trigger settings: Trigger Type, Trigger Channel, Trigger Coupling, Trigger Offset. The color of the settings reflects the channel that the oscilloscope will trigger on, in this example Ch1. Coupling Mode options are DC / AC / LF Reject / HF Reject.

The trigger level value of the current waveform is shown. Press the knob to reset the parameter to 50% of the waveform.

9. Channel Setting

Displays the channel settings including coupling mode. Options are: DC / AC / GND.

Displays the voltage Scale in Y axis volts per division.

BW Limit. If the "BW Limit" is "On", then a small capital "B" is displayed.

Channel Impedance is displayed (1 M Ω).

Displays currently selected probe attenuation factor. All factors are: 0.1X / 0.2X / 0.5X / 1X... / 1000X / 2000X / 5000X / 10000X.

10. Trigger Level Position

Displays the voltage position of the trigger channel trigger level. Press the knob to reset the level to vertical center of the displayed waveform.

11. I/O Connection Status



Indicates the USB Host is connected.

Indicates that a USB Device is connected.

Indicates that the LAN port is connected.

Indicates the LAN port is disconnected.

12. Menu

The softkey menus of the currently selected function. Press any menu softkey to select the corresponding action.

13. Zero Voltage Level Indicator

Indicator of where the zero voltage level is for each channel. One color coded marker for each channel.

Kensington Lock Point

14 marks the security connection point for connecting a Kensington style lock. To use, align the lock with the lock hole and insert, turn the key to lock the instrument and then remove the key from the lock (Lock is not included).

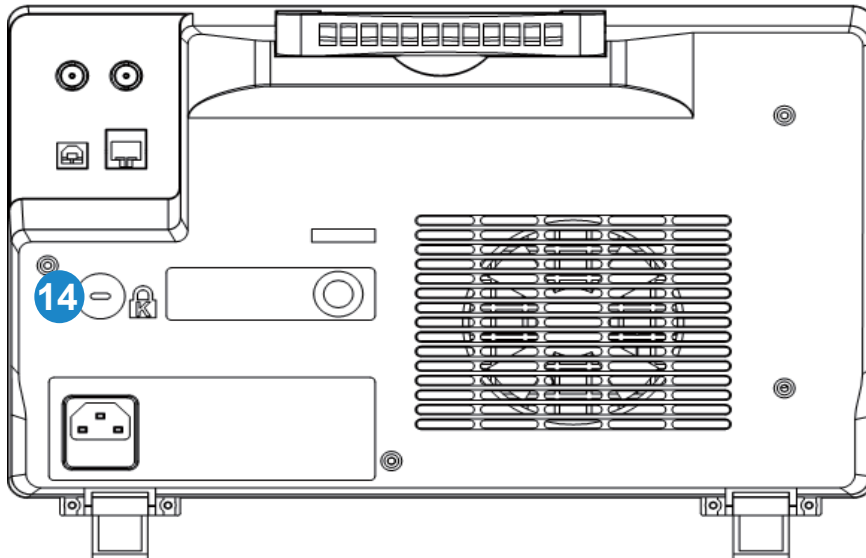

Troubleshooting

Commonplace problems and potential solutions are listed below. If the problem proves to be unsolvable, please contact Teledyne LeCroy Service Department as soon as possible for help and advice.

The screen remains blank after the power is turned on:

1. Check if the power is correctly connected.
2. Check if the power switch is off on the oscilloscope and wall socket connection.
3. Check whether the fuse has blown. If the fuse needs to be changed, please change the fuse for a fuse of the same specification. If this fuse blows immediately then please contact Teledyne LeCroy Service Department as soon as possible and return the instrument to the factory for repair.

After the signal is sampled, there is no corresponding waveform displayed:

1. Check if the probe is correctly connected to the DUT signal and to the oscilloscope BNC.
2. The probe can be checked by connecting it to the oscilloscope square wave compensation signal. This should produce a square wave on the scope display.
3. Check that the DUT is powered on and that it is generating waveforms.
4. Set the oscilloscope trigger to Auto. See if a waveform is displayed.

The voltage amplitude measured is higher or lower than the actual value (this error usually occurs when using a probe):

Check if the attenuation coefficient of the channel matches with the attenuation ratio of the probe.

There is an unstable waveform displayed:

1. Check the trigger source: check whether the “Source” in the “TRIG” menu is the actual operating channel.
2. Adjust the trigger level. An unstable waveform can be displayed if the trigger waveform is noisy. The waveform can often be stabilised by adjusting the trigger level.
3. Check the trigger type: “Edge” trigger suits general waveforms but can produce unstable waveforms on burst type signals such as video, modulated waveforms and serial bus waveforms.
4. Check and adjust the trigger holdoff. Trigger Holdoff does not allow the trigger to re-arm for a specified length of time. This is very useful for stabilising burst type waveforms.

There is no display after pressing Run / Stop:

Check whether the trigger Mode is “Normal” or “Single”, and if the trigger level exceeds the waveform range. The oscilloscope will not trigger if the trigger level exceeds the size of the waveform and the oscilloscope is in Normal or Single mode. Set the trigger to Auto Trigger and see if a waveform is displayed. The trigger level is usually out of range if the waveform is only displayed during Auto and not during Normal or Single. Alternatively the trigger type is incorrectly set up.

An aliased waveform is displayed:

The horizontal time base may be too low. Increase the horizontal time base to improve the horizontal resolution and remove the aliased waveform.

USB storage isn't recognized:

1. Not all USB storage is supported. Make sure the USB drive being used is flash and also check the size of the flash drive. Large USB flash storage is not supported.
2. USB 3.0 flash drives are not supported.
3. Make sure that the USB file format is FAT32.



ABOUT TELEDYNE TEST TOOLS

Company Profile

Teledyne LeCroy is a leading provider of oscilloscopes, protocol analyzers and related test and measurement solutions that enable companies across a wide range of industries to design and test electronic devices of all types. Since our founding in 1964, we have focused on creating products that improve productivity by helping engineers resolve design issues faster and more effectively. Oscilloscopes are tools used by designers and engineers to measure and analyze complex electronic signals in order to develop high-performance systems and to validate electronic designs in order to improve time to market.

The Teledyne Test Tools brand expands on the Teledyne LeCroy product portfolio by adding a comprehensive range of test equipment solutions for its customers. The new range of product solutions deliver engineers with a broad range of quality test solutions that enables speed to market product validation and design. More and more designers, engineers and lecturers are relying on Teledyne Test Tools to meet their testing, education and electronics validation needs with confidence and within budget.

Location and Facilities

Headquartered in Chestnut Ridge, New York, Teledyne Test Tools and Teledyne LeCroy have sales, service and development subsidiaries in the US and throughout Europe and Asia. Teledyne Test Tools and Teledyne LeCroy products are employed across a wide variety of industries, including semiconductor, computer, consumer electronics, education, military/aerospace, automotive/industrial, and telecommunications.

Teledyne LeCroy (US Headquarters)

700 Chestnut Ridge Road
Chestnut Ridge, NY. USA
10977-6499

Phone: 800-553-2769 or 845-425-2000

Fax Sales: 845-578-5985

Email Sales: contact.corp@teledynelecroy.com **Email**

Support: support@teledynelecroy.com (Oscilloscopes, Waveform Generators, Signal Integrity) **Web Site:**

<http://teledynelecroy.com/>

Phone Support: 1-800-553-2769

Teledyne LeCroy (European Headquarters)

Teledyne LeCroy GmbH

Im Breitspiel 11c
D-69126 Heidelberg, Germany

Phone: + 49 6221 82700

Fax: +49 6221 834655

Fax Sales: +49 6221 834655 **Fax**

Service: +41 22 719 22 99

Email Sales: contact.gmbh@teledynelecroy.com **Email**

Service: service.gmbh@teledynelecroy.com **Email**

Support: applications.de@teledynelecroy.com **Web**

Site: <http://teledynelecroy.com/germany> **Phone**

Service: +49 6221 8270 85

Phone Support: +49 6221 8270 28

