

RIGOL

User's Guide

DSA1000A Series Spectrum Analyzer

Sept. 2014

RIGOL Technologies, Inc.

Guaranty and Declaration

Copyright

© 2010 RIGOL Technologies, Inc. All Rights Reserved.

Trademark Information

RIGOL is a registered trademark of RIGOL Technologies, Inc.

Publication Number

UGD01116-1110

Software Version

This manual is applicable to software 00.01.17 or higher.

Software upgrade might change or add product features. Please acquire the latest version of the manual from **RIGOL** website or contact **RIGOL** to upgrade the software.

Notices

- **RIGOL** products are covered by P.R.C. and foreign patents, issued and pending.
- **RIGOL** reserves the right to modify or change parts of or all the specifications and pricing policies at company's sole decision.
- Information in this publication replaces all previously corresponding material.
- Information in this publication is subject to change without notice.
- **RIGOL** shall not be liable for either incidental or consequential losses in connection with the furnishing, use or performance of this manual as well as any information contained.
- Any part of this document is forbidden to be copied, photocopied or rearranged without prior written approval of **RIGOL**.

Product Certification

RIGOL guarantees this product conforms to the national and industrial standards in China as well as the ISO9001:2008 standard and the ISO14001:2004 standard. Other international standard conformance certification is in progress.

Contact Us

If you have any problem or requirement when using our products or this manual, please contact **RIGOL**.

E-mail: service@rigol.com

Websites: www.rigol.com

General Safety Summary

Please review the following safety precautions carefully before putting the instrument into operation so as to avoid any personal injury or damage to the instrument and any product connected to it. To prevent potential hazards, please use the instrument only specified by this manual.

Use Proper Power Cord.

Only the power cord designed for the instrument and authorized for use within the local country could be used.

Ground the Instrument.

The instrument is grounded through the Protective Earth lead of the power cord. To avoid electric shock, it is essential to connect the earth terminal of the power cord to the Protective Earth terminal before connecting any inputs or outputs.

Connect the Probe Correctly.

If a probe is used, do not connect the ground lead to high voltage since it has isobaric electric potential as the ground.

Observe All Terminal Ratings.

To avoid fire or shock hazard, observe all ratings and markers on the instrument and check your manual for more information about ratings before connecting the instrument.

Use Proper Overvoltage Protection.

Make sure that no overvoltage (such as that caused by a thunderstorm) can reach the product, or else the operator might be exposed to the danger of electrical shock.

Do Not Operate Without Covers.

Do not operate the instrument with covers or panels removed.

Do Not Insert Anything Into the Holes of Fan.

Do not insert anything into the holes of the fan to avoid damaging the instrument.

Use Proper Fuse.

Please use the specified fuses.

Avoid Circuit or Wire Exposure.

Do not touch exposed junctions and components when the unit is powered.

Do Not Operate With Suspected Failures.

If you suspect damage occurs to the instrument, have it inspected by qualified service personnel before further operations. Any maintenance, adjustment or replacement especially to circuits or accessories must be performed by **RIGOL** authorized personnel.

Keep Well Ventilation.

Inadequate ventilation may cause an increase of temperature or damage to the device. So please keep the instrument well ventilated and inspect the intake and fan regularly.

Do Not Operate in Wet Conditions.

In order to avoid short circuiting to the interior of the device or electric shock, please do not operate the instrument in a humid environment.

Do Not Operate in an Explosive Atmosphere.

In order to avoid damage to the device or personal injuries, it is important to operate the device away from an explosive atmosphere.

Keep Product Surfaces Clean and Dry.

To avoid the influence of dust and/or moisture in the air, please keep the surface of the device clean and dry.

Electrostatic Prevention.

Operate the instrument in an electrostatic discharge protective environment to avoid damage induced by static discharges. Always ground both the internal and external conductors of cables to release static before making connections.

Protect the Input Terminals of Instrument

Do not bend or hit the input terminals and the connected devices, (such as filter, attenuator, etc.) as such stress may cause damages to devices and the instrument.

Do not mix the use of 50Ω and 75Ω connectors and/or cables.

Do Not Overload the Input

To avoid damaging the instrument, the signals at input terminal must be less than 50V DC voltage components and 30 dBm (1 W) AC (RF) components (the frequency range is from 10 MHz to 3 GHz).

Appropriate Use of Power Meter

If you are not sure of the characteristics of signal under measure, follow these recommendations to ensure safe operations: if a RF power meter is available, use it to measure the power level of this signal first; or add a rated external attenuator between signal cable and input terminal of the instrument. Maximum attenuation, reference level and maximum span frequency should be selected, so as to make the signals displayed within the screen.

Know About the Specification Conditions of the Instrument

For maximum performance of the instrument, use the analyzer under specified conditions.

Proper Use of Battery.

If a battery is supplied, it must not be exposed to high temperature or in contact with fire. Keep it out of the reach of children. Improper change of battery (note: lithium battery) may cause explosion. Use **RIGOL** specified battery only.

Handling Safety.

Please handle with care during transportation to avoid damage to buttons, knob interfaces and other parts on the panels.

Safety Terms and Symbols

Terms Used in this Manual. These terms may appear in this manual:

**WARNING**

Warning statements indicate conditions or practices that could result in injury or loss of life.

**CAUTION**

Caution statements indicate conditions or practices that could result in damage to this product or other property.

Terms Used on the Product. These terms may appear on the Product:

DANGER indicates an injury or hazard may immediately happen.

WARNING indicates an injury or hazard may occur.

CAUTION indicates potential damage to the instrument or other property might occur.

Symbols Used on the Product. These symbols may appear on the product:



**Hazardous
Voltage**



**Safety
Warning**



**Protective
Earth
Terminal**



**Chassis
Ground**



**Test
Ground**

Allgemeine Sicherheits Informationen

Überprüfen Sie die folgenden Sicherheitshinweise sorgfältig um Personenschäden oder Schäden am Gerät und an damit verbundenen weiteren Geräten zu vermeiden. Zur Vermeidung von Gefahren, nutzen Sie bitte das Gerät nur so, wie in diesem Handbuch angegeben.

Um Feuer oder Verletzungen zu vermeiden, verwenden Sie ein ordnungsgemäßes Netzkabel.

Verwenden Sie für dieses Gerät nur das für ihr Land zugelassene und genehmigte Netzkabel.

Erden des Gerätes.

Das Gerät ist durch den Schutzleiter im Netzkabel geerdet. Um Gefahren durch elektrischen Schlag zu vermeiden, ist es unerlässlich, die Erdung durchzuführen. Erst dann dürfen weitere Ein- oder Ausgänge verbunden werden.

Anschluss eines Tastkopfes.

Die Erdungsklemmen der Sonden sind auf dem gleichen Spannungspegel des Instruments geerdet. Schließen Sie die Erdungsklemmen an keine hohe Spannung an.

Beachten Sie alle Anschlüsse.

Zur Vermeidung von Feuer oder Stromschlag, beachten Sie alle Bemerkungen und Markierungen auf dem Instrument. Befolgen Sie die Bedienungsanleitung für weitere Informationen, bevor Sie weitere Anschlüsse an das Instrument legen.

Verwenden Sie einen geeigneten Überspannungsschutz.

Stellen Sie sicher, daß keinerlei Überspannung (wie z.B. durch Gewitter verursacht) das Gerät erreichen kann. Andernfalls besteht für den Anwender die Gefahr eines Stromschlages.

Nicht ohne Abdeckung einschalten.

Betreiben Sie das Gerät nicht mit entfernten Gehäuse-Abdeckungen.

Betreiben Sie das Gerät nicht geöffnet.

Der Betrieb mit offenen oder entfernten Gehäuseteilen ist nicht zulässig. Nichts in entsprechende Öffnungen stecken (Lüfter z.B.)

Passende Sicherung verwenden.

Setzen Sie nur die spezifikationsgemäßen Sicherungen ein.

Vermeiden Sie ungeschützte Verbindungen.

Berühren Sie keine unisolierten Verbindungen oder Baugruppen, während das

Gerät in Betrieb ist.

Betreiben Sie das Gerät nicht im Fehlerfall.

Wenn Sie am Gerät einen Defekt vermuten, sorgen Sie dafür, bevor Sie das Gerät wieder betreiben, dass eine Untersuchung durch qualifiziertes Kundendienstpersonal durchgeführt wird. Jedwede Wartung, Einstellarbeiten oder Austausch von Teilen am Gerät, sowie am Zubehör dürfen nur von **RIGOL** autorisiertem Personal durchgeführt werden.

Belüftung sicherstellen.

Unzureichende Belüftung kann zu Temperaturanstiegen und somit zu thermischen Schäden am Gerät führen. Stellen Sie deswegen die Belüftung sicher und kontrollieren regelmäßig Lüfter und Belüftungsöffnungen.

Nicht in feuchter Umgebung betreiben.

Zur Vermeidung von Kurzschluß im Geräteinneren und Stromschlag betreiben Sie das Gerät bitte niemals in feuchter Umgebung.

Nicht in explosiver Atmosphäre betreiben.

Zur Vermeidung von Personen- und Sachschäden ist es unumgänglich, das Gerät ausschließlich fernab jedweder explosiven Atmosphäre zu betreiben.

Geräteoberflächen sauber und trocken halten.

Um den Einfluß von Staub und Feuchtigkeit aus der Luft auszuschließen, halten Sie bitte die Geräteoberflächen sauber und trocken.

Schutz gegen elektrostatische Entladung (ESD).

Sorgen Sie für eine elektrostatisch geschützte Umgebung, um somit Schäden und Funktionsstörungen durch ESD zu vermeiden. Erden Sie vor dem Anschluß immer Innen- und Außenleiter der Verbindungsleitung, um statische Aufladung zu entladen.

Die richtige Verwendung des Akku.

Wenn eine Batterie verwendet wird, vermeiden Sie hohe Temperaturen bzw. Feuer ausgesetzt werden. Bewahren Sie es außerhalb der Reichweite von Kindern auf. Unsachgemäße Änderung der Batterie (Anmerkung: Lithium-Batterie) kann zu einer Explosion führen. Verwenden Sie nur von RIGOL angegebene Akkus.

Sicherer Transport.

Transportieren Sie das Gerät sorgfältig (Verpackung!), um Schäden an Bedienelementen, Anschlüssen und anderen Teilen zu vermeiden.

Sicherheits Begriffe und Symbole

Begriffe in diesem Guide. Diese Begriffe können in diesem Handbuch auftauchen:

**WARNING**

Die Kennzeichnung WARNING beschreibt Gefahrenquellen die leibliche Schäden oder den Tod von Personen zur Folge haben können.

**CAUTION**

Die Kennzeichnung Caution (Vorsicht) beschreibt Gefahrenquellen die Schäden am Gerät hervorrufen können.

Begriffe auf dem Produkt. Diese Bedingungen können auf dem Produkt erscheinen:

DANGER weist auf eine Verletzung oder Gefährdung hin, die sofort geschehen kann.

WARNING weist auf eine Verletzung oder Gefährdung hin, die möglicherweise nicht sofort geschehen.

CAUTION bedeutet, dass eine mögliche Beschädigung des Instruments oder anderer Gegenstände auftreten kann.

Symbole auf dem Produkt. Diese Symbole können auf dem Produkt erscheinen:



GefährlicheS
pannung



Sicherheits-
Hinweis



Schutz-erde



Gehäusemasse



Erde

DSA1000A Series Overview

DSA1000A Series Spectrum Analyzer is designed with small volume, light weight, high cost performance, and having an easy-operated keyboard layout. Features include a high definition 8.5 inch TFT color LCD, easy to understand settings and messages on the display interface, standard or configurable USB, LAN and GPIB communication interfaces that enable users to display or control the instrument over virtual terminals and remote networks. It is widely used in education, science, corporate centers, industrial production and many other fields.

Main features:

- Frequency Range: 9 kHz to 3 GHz
- Display Average Noise Level (DANL): -148 dBm
- Phase Noise: -88 dBc/Hz @ 10 kHz offset (Typical)
- Total Amplitude Accuracy: <1.0 dB
- Minimum Resolution Bandwidth: 10 Hz
- Standard with EMI Filter and Quasi-Peak Detector
- Standard with Preamplifier
- 3 GHz Tracking Generator (DSA1030A-TG)
- Built-in lithium battery (China only), can provide power continuously for three hours
- Plenty of measurement functions and auto settings for choosing
- 8.5 inches widescreen display, clear and vivid interface, easy-to-use design
- Various interfaces such as LAN, USB Host, USB Device, VGA or GPIB (optional)
- Compact design with only 13.7 lbs (without battery)
- Enhance or expand analyzer functions by using the PC software, Ultra Spectrum

Document Overview

Chapter 1 Quick Start: This chapter introduces the front/rear panel and user interface, as well as announcements during first use of the analyzer, and shows the usage through a measurement example demo.

Chapter 2 Front Panel Key Reference: This chapter gives detailed function descriptions of the front panel keys with their associated menu keys.

Chapter 3 Measurement Examples: This chapter introduces the main functions and operations of the analyzer.

Chapter 4 Remote Control: This chapter shows how to control the analyzer in remote mode.

Chapter 5 Troubleshooting: This chapter lists the troubleshooting information and messages that may appear during the use of the analyzer.

Chapter 6 Specification: This chapter lists the general specifications of the analyzer.

Chapter 7 Menu Map: This chapter provides a visual representation of the front panel keys and their associated menu keys.

Chapter 8 Appendix: This chapter lists the options and accessories that can be ordered along with your analyzer as well as the service and support information.

- **Conventions for buttons and menu formats in this manual:**

Buttons: button name+textbox, such as **FREQ** indicates the **FREQ** function key.

Menu keys: menu word+character shading, such as **Center Freq** indicates the center frequency menu under the **FREQ** function.

- **User manuals provided by our product:**

Mainly include User's Guide, Quick Guide, Programming Guide and Data sheet.

Hint:

For the newest version of this manual please download from this URL:
<http://www.rigol.com>

Contents

Guaranty and Declaration	I
General Safety Summary	II
Safety Terms and Symbols.....	V
Allgemeine Sicherheits Informationen.....	VI
Sicherheits Begriffe und Symbole	VIII
DSA1000A Series Overview.....	IX
Document Overview.....	X
Chapter 1 Quick Start	1-1
Front Panel	1-2
Front Panel Function Key	1-3
Front Panel Backlight Key	1-6
Front Panel Connector	1-8
Rear Panel	1-10
Prepare for Use.....	1-13
General Inspection.....	1-13
Disassemble the Front Panel Cover	1-14
Adjust the Supporting Legs	1-14
Connect the Power	1-15
Power-On Check	1-17
Self Calibration	1-17
Use the Lock	1-17
Change the Fuse.....	1-18
Charge the Battery (China Only).....	1-19
User Interface	1-20
Menu Operation.....	1-24
Parameter Input.....	1-26
Numeric Keyboard.....	1-26
Knob	1-27
Direction key	1-28
Basic Measurement.....	1-29
Ultra Spectrum	1-31
How to Use the Built-in Help.....	1-31

Chapter 2 Front Panel Key Reference	2-1
Basic Settings	2-2
FREQ.....	2-2
SPAN.....	2-9
AMPT	2-11
Sweep Settings	2-21
BW.....	2-21
Sweep	2-24
Auto Tune.....	2-27
Trig	2-29
Single.....	2-31
Continue.....	2-32
Function Settings	2-33
Detector	2-33
Trace.....	2-37
Demod	2-41
Source (DSA1030A-TG)	2-43
Advanced Measurements	2-48
Meas	2-48
Meas Setup.....	2-51
Marker Measurements	2-76
Marker.....	2-76
Marker->	2-83
Marker Fctn	2-85
Peak.....	2-88
L-Peak	2-92
R-Peak.....	2-92
System Functions	2-93
System	2-93
Display	2-101
Preset.....	2-105
Storage	2-111
Print Setup.....	2-116
Print.....	2-119
Screen Control	2-120
Full Screen.....	2-120
Next Window	2-121

Zoom.....	2-122
Chapter 3 Measurement Examples	3-1
Measuring a Sine Signal.....	3-2
Using the Frequency Counter.....	3-4
Measuring an AM Signal	3-6
Measuring the Phase Noise.....	3-9
Measuring the N dB Bandwidth	3-11
Measuring the Time-Domain Power.....	3-13
Measuring the Adjacent Channel Power	3-15
Measuring the Channel Power	3-17
Measuring the Occupied Bandwidth	3-19
Measuring the Emission Bandwidth.....	3-21
Measuring the Carrier-to-Noise Ratio.....	3-23
Measuring the Harmonic Distortion	3-25
Measuring the TOI Distortion	3-29
Pass/Fail Measurement	3-32
Amplitude Correction.....	3-34
Tracking Generator (DSA1030A-TG).....	3-36
Chapter 4 Remote Control	4-1
Remote Control via USB.....	4-2
Remote Control via LAN.....	4-4
Remote Control via GPIB	4-7
Chapter 5 Troubleshooting.....	5-1
Troubleshooting	5-1
Messages.....	5-3
Information Message.....	5-5
Error Message	5-7
Status Message	5-20
Chapter 6 Specification	6-1
Technical Specification*	6-2
Frequency.....	6-2
Amplitude	6-3
Sweep	6-6
Trigger.....	6-6
Tracking Generator (DSA1030A-TG)	6-7
Input/Output.....	6-7

General Specification	6-9
Chapter 7 Menu Map	7-1
AMPT	7-2
BW	7-3
Demod	7-4
Detector	7-5
Display	7-6
FREQ	7-7
Marker	7-8
Marker Fctn	7-9
Marker->	7-10
Meas	7-11
Meas Setup	7-12
T-Power	7-12
ACP	7-13
Channel Power	7-13
OBW	7-14
EBW	7-14
C/N Ratio	7-15
Harmonics Dist	7-15
TOI	7-16
Pass/Fail	7-16
Peak	7-17
Print Setup	7-18
SPAN	7-19
Storage	7-20
Sweep	7-21
System	7-22
Source (DSA1030A-TG)	7-26
Trace	7-27
Trig	7-28
Chapter 8 Appendix	8-1
Appendix A: Ordering Information	8-1
Appendix B: Warranty	8-3
Appendix C: General Care and Cleaning	8-4
Index	1

List of Figures

Figure 1-1 Front panel overview	1-2
Figure 1-2 Function key area.....	1-3
Figure 1-3 Front Panel Connectors.....	1-8
Figure 1-4 USB Host interface connections	1-8
Figure 1-5 Tracking generator output connection	1-9
Figure 1-6 RF input connection.....	1-9
Figure 1-7 Rear panel overview	1-10
Figure 1-8 TRIGGER IN connection	1-11
Figure 1-9 10 MHz IN/OUT connection	1-11
Figure 1-10 VGA port connection	1-11
Figure 1-11 PictBridge printer connection	1-12
Figure 1-12 USB remote control connection	1-12
Figure 1-13 LAN connection	1-12
Figure 1-14 Disassemble the front panel cover.....	1-14
Figure 1-15 Adjust the supporting legs.....	1-14
Figure 1-16 Power cord connection.....	1-15
Figure 1-17 Install the Battery.....	1-16
Figure 1-18 Use the lock.....	1-17
Figure 1-19 Change the fuse.....	1-18
Figure 1-20 User interface	1-20
Figure 1-21 The Numerical keyboard	1-26
Figure 1-22 The knob.....	1-27
Figure 1-23 Direction keys	1-28
Figure 1-24 Measuring result.....	1-30
Figure 1-25 Built-in help	1-32
Figure 2-1 Process of signal tracking.....	2-6
Figure 2-2 Before the Peak->CF	2-7
Figure 2-3 After the Peak->CF.....	2-8
Figure 2-4 Before the Auto Scale	2-11
Figure 2-5 After the Auto Scale	2-11
Figure 2-6 Before the Auto Range.....	2-16
Figure 2-7 After the Auto Range.....	2-16
Figure 2-8 Process of the Auto Range	2-17
Figure 2-9 Before the Auto Tune.....	2-27

Figure 2-10 After the Auto Tune	2-27
Figure 2-11 Process of a single sweep	2-31
Figure 2-12 Process of continue sweep	2-32
Figure 2-13 Working principle of the detector	2-33
Figure 2-14 Power sweep	2-44
Figure 2-15 Interface of T-Power measurement	2-51
Figure 2-16 Interface of ACP measurement	2-54
Figure 2-17 Interface of Chan Pwr measurement	2-57
Figure 2-18 Interface of OBW measurement.....	2-60
Figure 2-19 Interface of EBW measurement	2-63
Figure 2-20 Interface of C/N Ratio measurement	2-66
Figure 2-21 Interface of Harmo Dist measurement.....	2-69
Figure 2-22 Interface of TOI measurement	2-72
Figure 2-23 Interface of Pass/Fail measurement	2-74
Figure 2-24 Schematic of the marker	2-76
Figure 2-25 The marker schematic	2-82
Figure 2-26 N dB BW measurement.....	2-86
Figure 2-27 Frequency Count measurement	2-87
Figure 2-28 Peak Table.....	2-91
Figure 2-29 LAN parameter setting.....	2-94
Figure 2-30 Classic display.....	2-103
Figure 2-31 Modern display	2-104
Figure 2-32 File operation manager	2-111
Figure 2-33 PictBridge printer connection.....	2-116
Figure 2-34 Full screen display.....	2-120
Figure 2-35 Switch between windows.....	2-121
Figure 3-1 Measuring a Sine signal	3-3
Figure 3-2 Use the frequency counter to measure.....	3-5
Figure 3-3 Measure an AM signal.....	3-7
Figure 3-4 Phase noise measurement	3-10
Figure 3-5 N dB bandwidth measurement result	3-12
Figure 3-6 Time-domain power measurement.....	3-14
Figure 3-7 Adjacent channel power measurement result.....	3-16
Figure 3-8 Channel power measurement result.....	3-18
Figure 3-9 Occupied bandwidth measurement result	3-20
Figure 3-10 Emission bandwidth measurement result	3-22
Figure 3-11 C/N Ratio measurement result.....	3-24

Figure 3-12 Use marker to measure harmonics	3-26
Figure 3-13 Harmonic Distortion measurement result	3-28
Figure 3-14 Use marker function to measure TOI distortion.....	3-30
Figure 3-15 Use TOI function to measure TOI distortion	3-31
Figure 3-16 Pass/Fail testing	3-33
Figure 3-17 Amplitude correction.....	3-35
Figure 3-18 The frequency response of a filter.....	3-37
Figure 4-1 View the resource	4-2
Figure 4-2 Write and read commands via USB	4-3
Figure 4-3 Search LAN resources	4-4
Figure 4-4 View the resource	4-5
Figure 4-5 Write and read commands via LAN.....	4-5
Figure 4-6 LXI Webpage	4-6
Figure 4-7 GPIB Setting	4-7
Figure 4-8 View the GPIB resource	4-8
Figure 4-9 Write and read commands via GPIB	4-9

List of Tables

Table 1-1 Front Panel Description	1-2
Table 1-2 Function keys description	1-3
Table 1-3 User interface legends	1-20
Table 2-1 Center Frequency	2-3
Table 2-2 Start Frequency.....	2-3
Table 2-3 Stop frequency.....	2-4
Table 2-4 CF step	2-5
Table 2-5 Span	2-9
Table 2-6 Reference level	2-12
Table 2-7 Input attenuation	2-13
Table 2-8 Scale.....	2-13
Table 2-9 Reference level offset	2-15
Table 2-10 Edit menus of Amplitude correction	2-18
Table 2-11 Max mixing level.....	2-19
Table 2-12 RBW.....	2-21
Table 2-13 VBW.....	2-22
Table 2-14 V/R Ratio	2-22
Table 2-15 Sweep time	2-24
Table 2-16 Numbers.....	2-25
Table 2-17 Points.....	2-26
Table 2-18 Trigger level.....	2-30
Table 2-19 Average times	2-38
Table 2-20 Constant in math operation	2-39
Table 2-21 Volume.....	2-41
Table 2-22 Demod Time	2-42
Table 2-23 TG level.....	2-43
Table 2-24 TG Level Offset	2-44
Table 2-25 Power Range of TG.....	2-45
Table 2-26 Frequency Offset	2-45
Table 2-27 Reference level under normalization	2-46
Table 2-28 TG reference position.....	2-47
Table 2-29 Average number for T-Power measurement.....	2-52
Table 2-30 The Start Line under T-Power measurement.....	2-53
Table 2-31 The Stop Line under T-Power measurement	2-53

Table 2-32 Average number for ACP measurement	2-55
Table 2-33 The main channel bandwidth of ACP measurement	2-55
Table 2-34 The adjacent channel bandwidth of ACP measurement	2-56
Table 2-35 Spacing of the ACP measurement	2-56
Table 2-36 Average number for Chan Pwr measurement	2-58
Table 2-37 Integral bandwidth of Chan Pwr measurement.....	2-58
Table 2-38 The Channel span of Chan Pwr measurement	2-59
Table 2-39 Average number for OBW measurement	2-61
Table 2-40 The Span of OBW measurement.....	2-61
Table 2-41 The Power Ratio of OBW measurement.....	2-62
Table 2-42 Average number for EBW measurement	2-64
Table 2-43 The Span of EBW measurement	2-64
Table 2-44 X dB	2-65
Table 2-45 Average number for C/N Ratio measurement	2-67
Table 2-46 The Offset Freq of C/N Ratio measurement	2-67
Table 2-47 Noise BW of C/N Ratio measurement	2-68
Table 2-48 The Carrier BW of C/N Ratio measurement.....	2-68
Table 2-49 Average number for Harmo Dist measurement.....	2-70
Table 2-50 Number of harmonics for Harmo Dist measurement	2-70
Table 2-51 The Sweep Time of Harmo Dist measurement	2-71
Table 2-52 Average number for TOI measurement	2-73
Table 2-53 The Span of TOI measurement	2-73
Table 2-54 Pass/Fail menu	2-75
Table 2-55 Marker parameters.....	2-77
Table 2-56 N dB BW parameter settings	2-86
Table 2-57 The resolution of frequency counter	2-87
Table 2-58 PK Excursn.....	2-90
Table 2-59 PK Thresh	2-90
Table 2-60 GPIB address.....	2-95
Table 2-61 Display line	2-101
Table 2-62 Graticule	2-102
Table 2-63 Brightness setting	2-103
Table 2-64 Factory Default	2-105
Table 2-65 File icons.....	2-111
Table 2-66 File type.....	2-112
Table 2-67 The printing state icons	2-117

Chapter 1 Quick Start

This chapter introduces the front/rear panel and the user interface, as well as announcements during first use of the analyzer, and shows the usage through a measurement example demo.

Subjects in this chapter:

- Front Panel
- Rear Panel
- Prepare for Use
- User Interface
- Menu Operation
- Parameter Input
- Basic Measurement
- Ultra Spectrum
- How to Use the Built-in Help

Front Panel

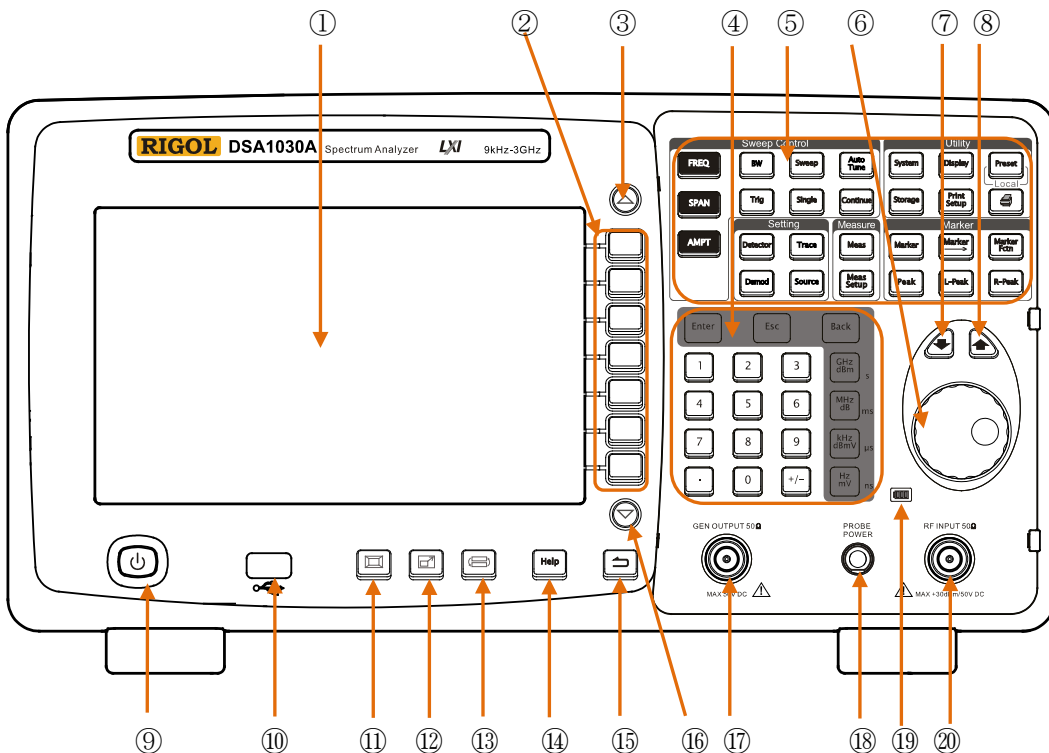

Figure 1-1 Front panel overview

Table 1-1 Front Panel Description

NO.	Description	NO.	Description
①	LCD	⑪	Full screen
②	Menu key	⑫	Zoom window
③	page up	⑬	Switch window
④	Numeric keyboard	⑭	One-button help
⑤	Function key area	⑮	Back
⑥	Knob	⑯	Page down
⑦	Down	⑰	Tracking generator output*
⑧	Up	⑱	Probe power output
⑨	Power key	⑲	Battery status indicator (China Only)
⑩	USB Host interface	⑳	RF input

Note*: This function is only applicable to DSA1030A-TG.

Front Panel Function Key

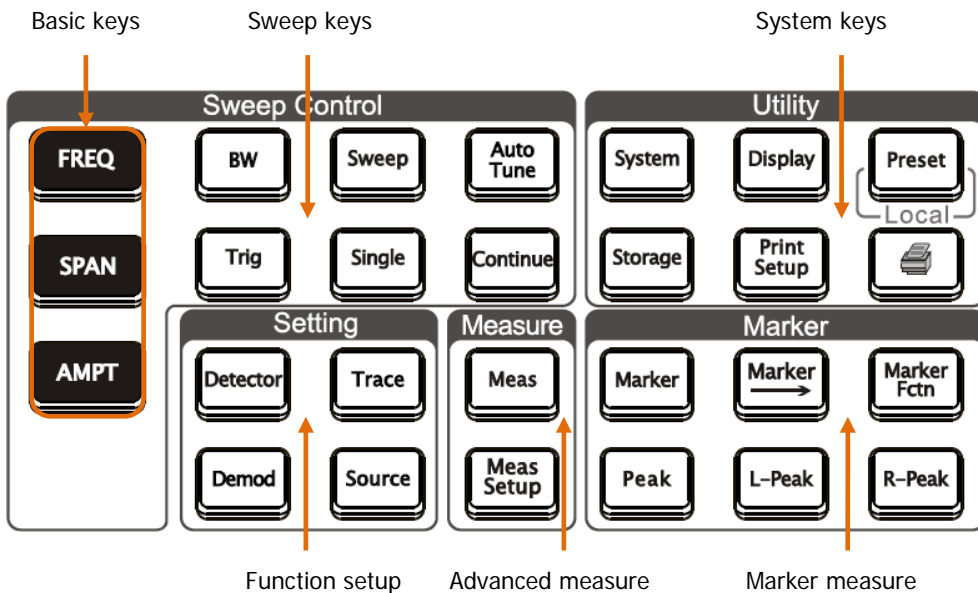

















Figure 1-2 Function key area







Table 1-2 Function keys description

Keys	Description
Sweep keys	
	Sets the center, start and stop frequency, as well as the signal tracking function.
	Sets the frequency sweep span.
	Sets the reference level, RF attenuator, scale and the unit of Y-axis, etc.
	Sets the Resolution Bandwidth and Video Bandwidth of the analyzer.
	Sets the sweep time, sweep mode, sweep numbers in single mode and the sweep points.
	Searches signals automatically within full frequency range.

Function keys description (Continued)

Keys	Description
	Sets the trigger mode and corresponding parameters.
	Sets the sweep mode to Single.
	Sets the sweep mode to Continue.
Function setup	
	Sets the detection mode of the analyzer.
	Sets the parameters relate to sweep trace.
	Sets the demodulation.
	Sets the tracking generator*.
Advanced measure	
	Select a desired advanced measurement function.
	Sets the parameters for the selected measurement function.
Marker measure	
	Reads the amplitude, frequency and sweep time of a certain point on the trace.
	Sets other system parameters based on the current marker value.
	Special function such as noise marker, N dB bandwidth measure and frequency counting.
	Searches the peak and opens the Peak menu immediately.
	Measures the left peak directly.
	Measures the right peak directly.

Function keys description (Continued)

Keys	Description
System keys	
 System	Sets the system parameters.
 Display	Sets the display parameters.
 Preset	Executes the selected preset function, resets the system into specified status, modifies all sweep parameters, measure settings as well as system parameters for following measure.
 Storage	Enter the storage interface.
 Print Setup	Sets the print parameters.
 	Print or save current screen.

Note*: This function is only applicable to DSA1030A-TG.

Front Panel Backlight Key

The backlight status of some keys at the front panel, off, bright or different color indicates different working mode.

1. AutoTune

When **Auto Tune** is pressed, the backlight turns on, which indicates that the instrument starts sweeping at full range, searching the signal of maximum amplitude, and moves it to the center of the screen. Then the backlight turns off.

2. Single, Continue

When backlights of **Single** or **Continue** are on, it indicates the current sweep mode is Single or Continue, respectively.

3. Meas

The backlight of **Meas** will be automatically turned on once any measurements are activate, and stay on until all measurement functions are disabled.

4. Source*

When backlight of **Source** is on, it indicates that the tracking generator is enabled, and vice versa.

5. Power light

In AC power supply mode:

- Flashes on and off alternatively: indicating the unit is in stand-by state.
- Constant on: indicating the normal operating condition.

In battery power supply mode (China only):

- Off: indicating the standby state.
- Constant on: indicating the normal operating condition.

6. Battery status indicator (China Only)

It is used to indicate the installation status and the current amount of electricity of the battery.

- Green: battery electricity > 80%
- Orange: 20% < battery electricity < 80%
- Red: battery electricity < 20%
- Off: the battery is not installed or the battery contains no electricity

Note*: This function is only applicable to DSA1030A-TG.

Front Panel Connector

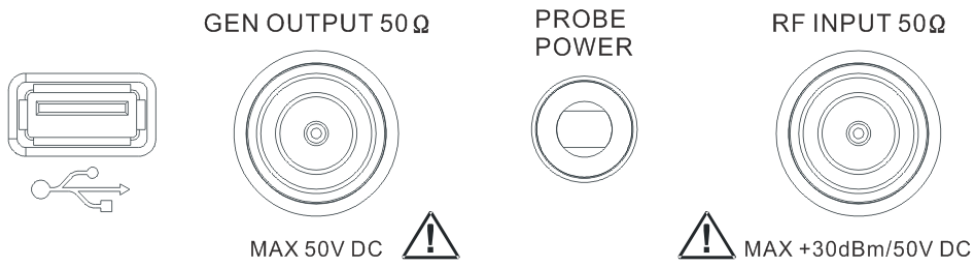

Figure 1-3 Front Panel Connectors

1. USB Host

The analyzer may serve as a “host” device to connect to external USB devices. This interface is available for USB storage devices and the USB-GPIB module. See the following connections:

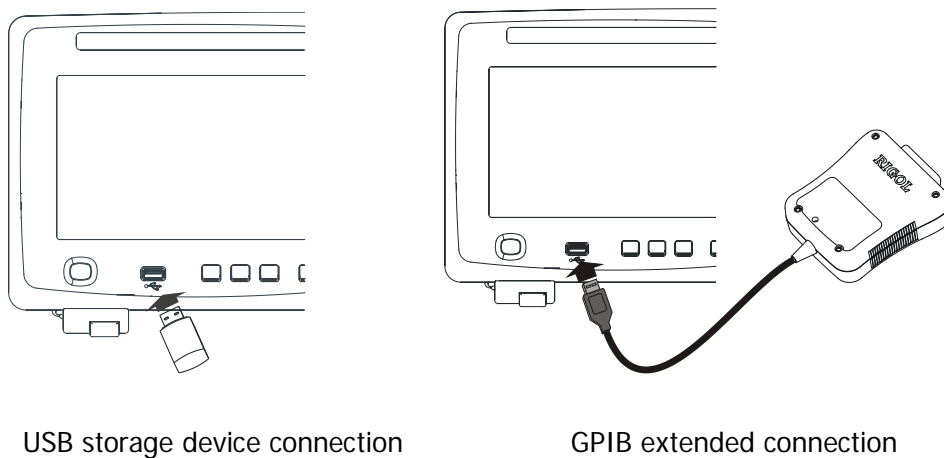

Figure 1-4 USB Host interface connections

2. GEN OUTPUT 50Ω

The output of the tracking generator can be connected to a receiver through an N male connector, see figure below. Note that the tracking generator function is only applicable to DSA1030A-TG.

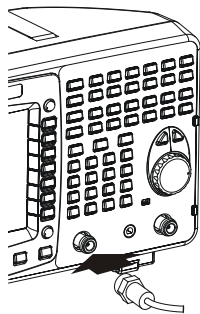

Figure 1-5 Tracking generator output connection

**CAUTION**

Reverse power or voltage mustn't be higher than 1 W or 50 V DC to avoid damages to the tracking generator.

3. PROBE POWER

This connector provides two lines of power supply to a RF probe: 15 V, 150 mA, and -12.6 V, 150 mA.

4. RF INPUT 50Ω

The RF input may be connected to a device under measure via an N male connector, see figure below.

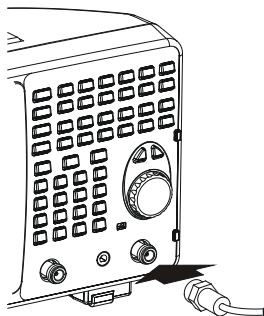

Figure 1-6 RF input connection

**CAUTION**

To avoid damages to the instrument, signals at the input terminal must be less than 50 V DC voltage components and 30 dBm (1 W) AC (RF) components.

Rear Panel

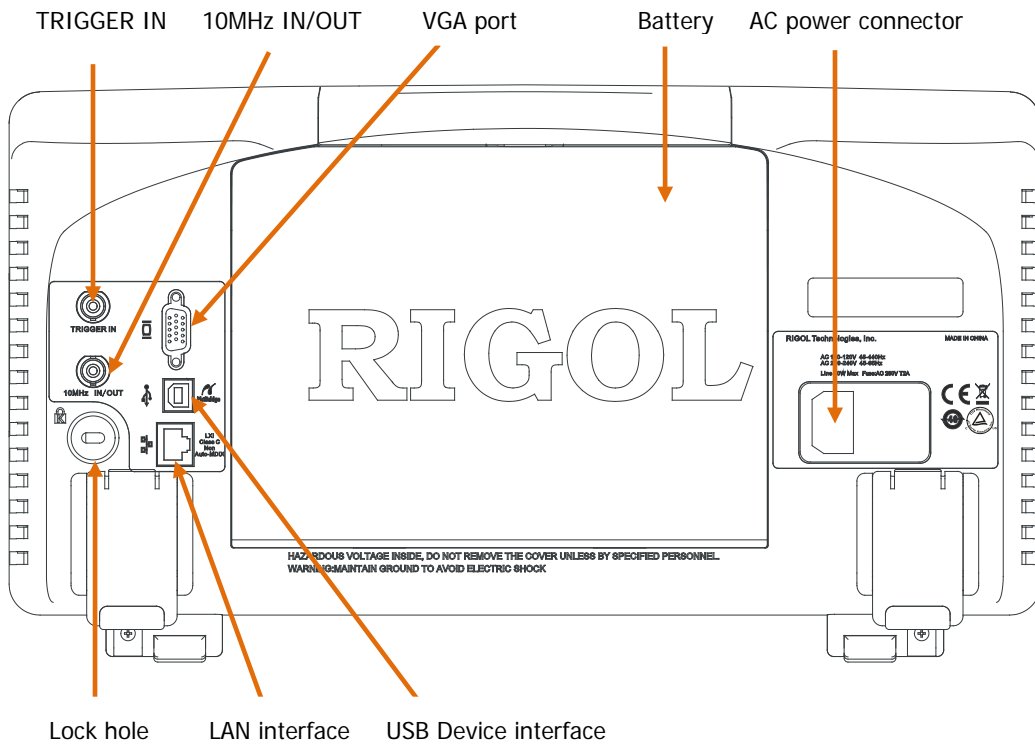

Figure 1-7 Rear panel overview

1. AC power connector

Available AC power supply types:

AC: 100 V - 120 V, 45 Hz - 440 Hz

AC: 200 V - 240 V, 45 Hz - 65 Hz

2. Rechargeable battery (China Only)

An optional power source of 10 V - 18 V, a fully charged battery can provide 3 hours of continuous operation.

3. TRIGGER IN

A BNC external trigger signal input port, see figure below.

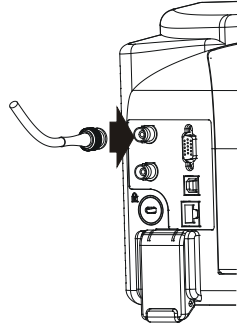

Figure 1-8 TRIGGER IN connection

4. 10MHz IN/OUT

The BNC input or output of the 10 MHz reference clock, see figure below.

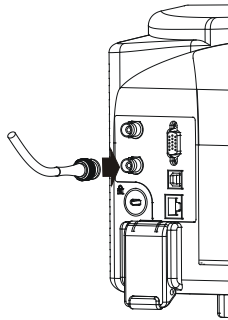

Figure 1-9 10 MHz IN/OUT connection

5. VGA port

This port provides a VGA signal output which is used through a VGA cable, see figure below.

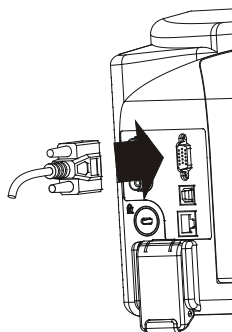

Figure 1-10 VGA port connection

6. USB Device interface

This configurable USB port permits external USB devices. It supports PictBridge printer and remote control connection.

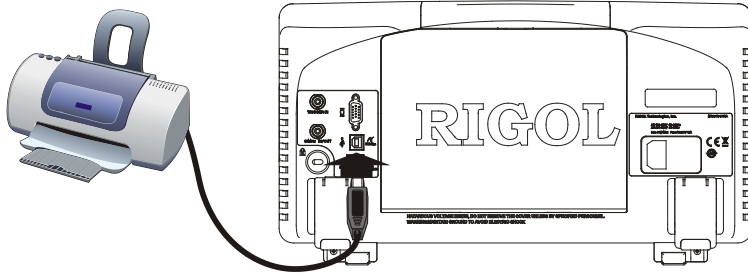

Figure 1-11 PictBridge printer connection

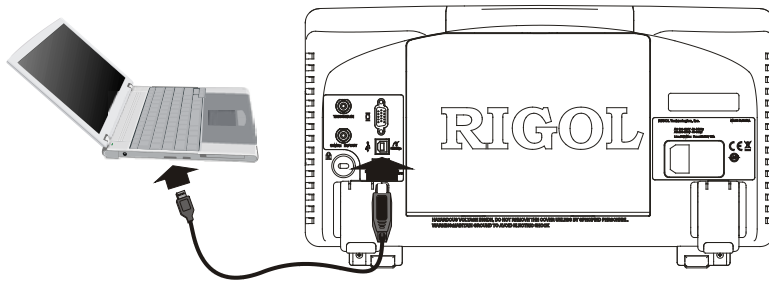

Figure 1-12 USB remote control connection

7. LAN interface

Through this interface, the analyzer can be connected to your local network for remote control. An integrated testing system can be built quickly, as the analyzer conforms to the LXI Core 2011 Device class instrument standards.

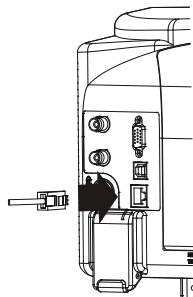

Figure 1-13 LAN connection

Prepare for Use

General Inspection

1. Inspect the shipping container for damage

Keep the damaged shipping container or cushioning material until the contents of the shipment have been checked for completeness and the instrument has passed both electrical and mechanical tests.

The consigner or carrier shall be liable for the damage to instrument resulting from shipment. **RIGOL** would not be responsible for free maintenance/rework or replacement of the unit.

2. Inspect the instrument

In case of any damage, or defect, or failure, notify your **RIGOL** sales representative.

3. Check the accessories

The accessories supplied with the instrument are listed in "**Appendix A: Option and Accessories**". If the accessories are incomplete or damaged, please notify your **RIGOL** sales representative.

Disassemble the Front Panel Cover

Before putting your analyzer into action, remove the front panel cover by releasing latches at both sides, and sliding in the direction of the arrows as shown in the figure below.

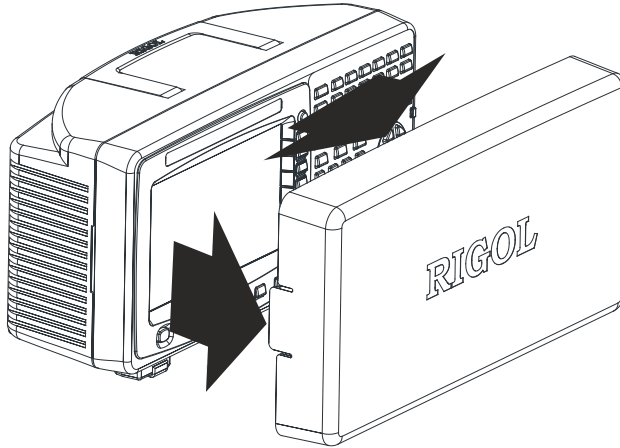

Figure 1-14 Disassemble the front panel cover

Adjust the Supporting Legs

If necessary, adjust the supporting legs of the analyzer to an appropriate position in the direction of the arrows as shown in the figure below.

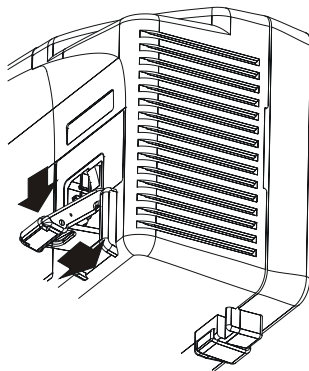

Figure 1-15 Adjust the supporting legs

Connect the Power

The spectrum analyzer can use AC power or rechargeable battery (China only) for power supply.

Connect the AC Power

Please use the power cord provided for AC powering, see figure below. For the AC voltage and frequency requirements, refer to "**Rear Panel**".

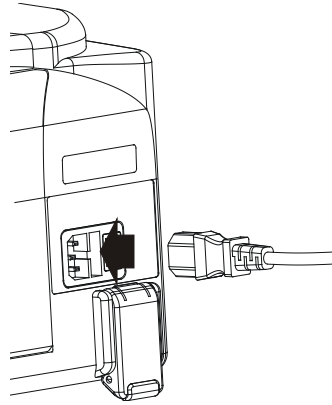



Figure 1-16 Power cord connection



CAUTION

Please ensure the instrument has been grounded correctly to avoid electrical shock.

Use the Battery (China Only)

The spectrum analyzer provides optional rechargeable battery. Please install the battery according to Figure 1-17. The battery status indicator  at the front panel indicates the installation status and the current amount of electricity of the battery.

- Green: battery electricity >80%
- Orange: 20% < battery electricity < 80%
- Red: battery electricity < 20%
- Off: the battery is not installed or the battery contains no electricity

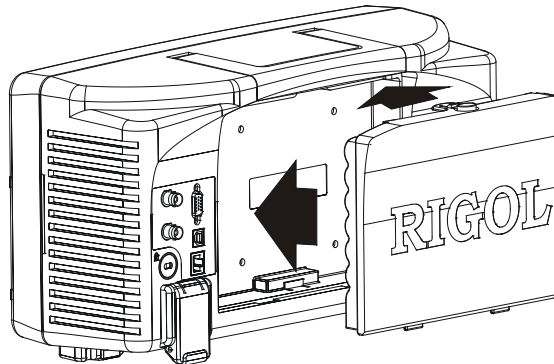

Figure 1-17 Install the Battery

The battery is rechargeable. For the charge method, refer to the introduction in “**Charge the Battery**”.



WARNING

Make sure the instrument is not connected to the AC power before installing the battery.

Power-On Check

Turn on the power switch at the rear panel, then press down the power button  on the front panel. You can monitor the initialization process according to the progress indicator during power-on. Upon completion of the initialization process, a sweep curve would be displayed.

Self Calibration

Press **System** → **Calibrate** → **Cal Now**, to use internal calibration resources to calibrate the system.

Use the Lock

If necessary, use a security lock to lock the analyzer in a desired location. See figure below, place the key into the lock hole in the direction of the arrow, turn it clockwise and then remove the key.

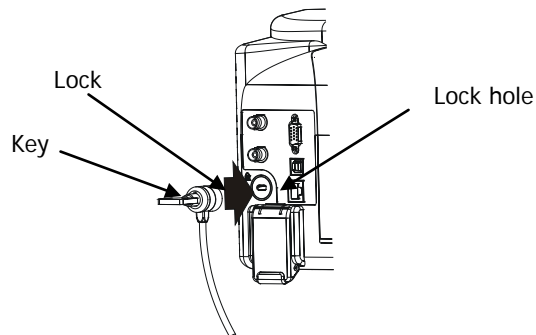

Figure 1-18 Use the lock

Change the Fuse

Please replace with specified fuse according to the following steps when needed:

1. Turn off the instrument, cut off the power and remove the power cord;
2. Prize out the fuse holder using a small straight screwdriver;
3. Take out the fuse;
4. Replace the old fuse with a specified one;
5. Re-install the fuse holder.

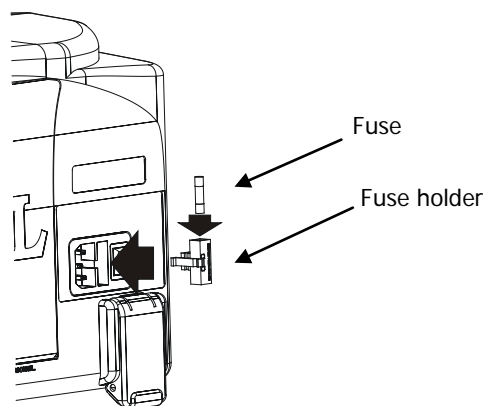

Figure 1-19 Change the fuse



WARNING

Please ensure that the instrument has been turned off and the power source has been cut off before replacing the fuse in order to avoid electrical shock.

Charge the Battery (China Only)

Please install the battery by referring to the introduction in “**Use the Battery**”. Then, connect the AC power and turn on the power switch at the rear panel to charge the battery. At this point, the power key at the front panel can be in any state.

The battery status indicator  at the front panel indicates the charge progress. If the battery status indicator does not go on, the battery contains no electricity currently. If the battery status indicator still does not go on after the battery has been charged for half an hour, please cut off the AC power and check whether the battery is correctly installed or whether it is damaged.

No matter whether the spectrum analyzer is in start-up or standby state, about 10 hours are required for the battery to be fully charged.

User Interface

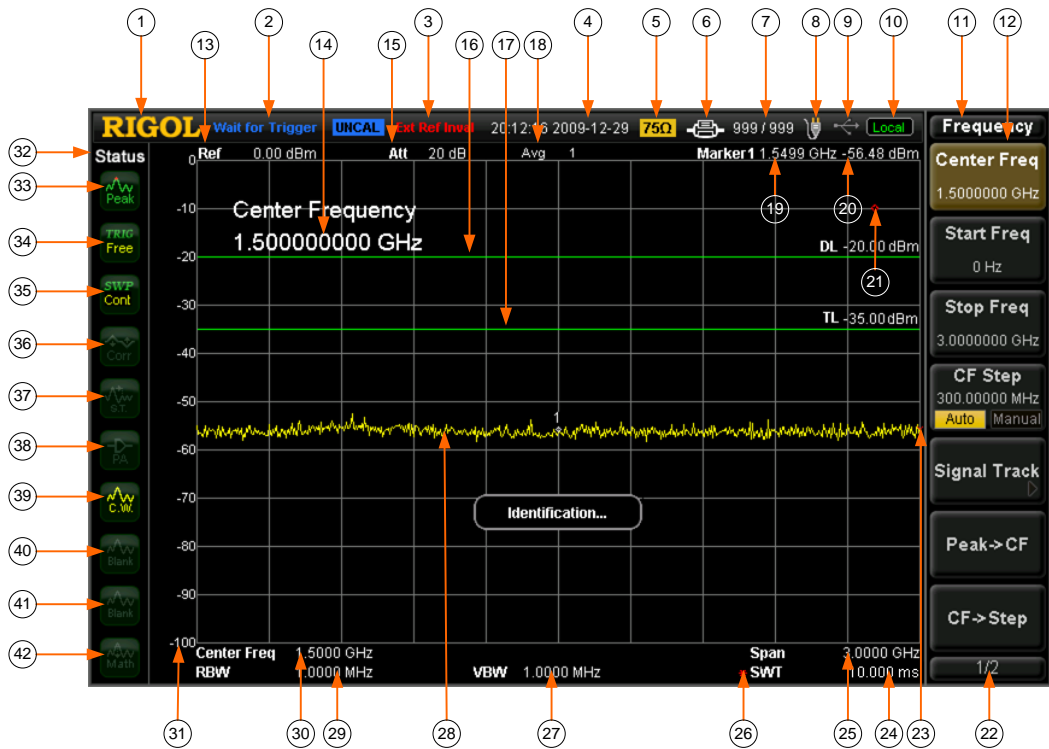











Figure 1-20 User interface

Table 1-3 User interface legends

NO.	Name	Description
1	LOGO	Logo of RIGOL company
2	System status ("UNCAL" and "Identification..." are in different locations)	Auto Tune Auto Range Wait for Trigger Calibrating UNCAL (Measurement Uncalibrated) Identification... (LXI Identification)
3	External reference	Ext Ref Ext Ref Invalid
4	Time	System time

User interface legends (Continued)

NO.	Name	Description
5	Input impedance	Show "75Ω" if the current input impedance is 75Ω.
6	Printer status	  : Alternate display, denotes the printer now is connecting.  : Successful connection, print finish or idle.   : Alternate display, denotes printing.  : Denotes print has been paused.
7	Print process	Show current print copy and total print copies.
8	Power status	AC supply:  Battery supply (China only): show electric quantity left 
9	USB storage device	Show if USB storage device is inserted; the mark  indicates successfully installed.
10	Operation status	Local or Rmt (Remote).
11	Menu title	Function of current menu belongs to.
12	Menu item	Menu item of current function.
13	Reference level	Reference level.
14	Active area	Current parameter and value.
15	Attenuator settings	Sets the Attenuator.
16	Display line	Reading reference and threshold condition for peak value.
17	Trigger level	Sets the trigger level in video trigger.
18	Average times	Average times of trace.
19	Cursor X	Current value of Cursor X. Note that X indicates different physical quantity in different functions.
20	Cursor Y	Current value of Cursor Y. Note that Y indicates different physical quantity in different functions.
21	Invalid data	Current measured data is invalid as a full sweep didn't complete after the system parameters have been modified.
22	Menu pages	Show total number of pages and current page number.
23	Sweep position	Current sweep position.
24	Sweep time	Sweep time.

User interface legends (Continued)

NO.	Name	Description
25	Span or stop frequency	The frequency range of current sweep channel can be expressed by a combination of center frequency and span or a combination of start frequency and stop frequency.
26	Manual symbol	Parameters non-auto coupling.
27	VBW	Video bandwidth.
28	Spectrum line area	For displaying spectrum line.
29	RBW	Resolution bandwidth.
30	Center or starting frequency	The frequency range of current sweep channel can be expressed by a combination of center frequency and span or a combination of starting frequency and stop frequency.
31	Y scale	Label of Y scale.
32	Parameter status	Icons on the left side of the screen indicate the status of system parameters.
33	Detection type	Pos peak, Neg peak, Sample, Normal, RMS Avg, Voltage Avg and Quasi-Peak.
34	Trigger type	Free, video and external.
35	Sweep mode	Continuous or Single sweep (with current sweeping times showing)
36	Correction switch	Turn the Correction On or Off.
37	Signal tracking	Enable or disable signal tracking.
38	Preamplifier status	Enable or disable the preamplifier.
39	Trace 1 types and status	Trace types: Clear Write, Max Hold, Min Hold, Video Avg and Power Avg. Trace status: yellow denotes On, and gray denotes Off.
40	Trace 2 types and status	Trace types: Clear Write, Max Hold, Min Hold, Video Avg and Power Avg. Trace status: purple denotes On, and gray denotes Off.

User interface legends (Continued)

NO.	Name	Description
41	Trace 3 types and status	Trace types: Clear Write, Max Hold, Min Hold, Video Avg and Power Avg. Trace status: light blue denotes On, and gray denotes Off.
42	MATH trace types and status	Trace types: A-B, A+C, A-C. Trace status: green denotes On, and gray denotes Off.

Menu Operation

There are 7 different menus with respect to different modes of operation:

1. Parameter Input

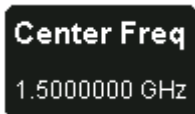

Press the corresponding menu and use the keyboard to modify the parameter directly.

For example: select **Center Freq**, input the desired value using the keyboard and select the desired unit from the pop-up unit menu or unit keys. You can also press **Enter** to select the default unit (MHz).

2. State Switching



Press corresponding menu key to switch the sub option shown.

For example: press **Signal Track** → **On/Off** to turn on or off the tracking.

3. Enter Lower Menu (with parameter)

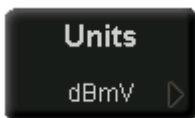

Press corresponding menu key to enter the lower menu and change its options.

For example: press **Units** to enter and select **dBmV**, the units for the Y-axis will be changed to dBmV after you return to the previous menu.

4. Enter Lower Menu (without parameter)

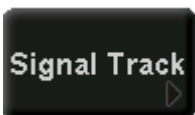

Press corresponding menu key to enter the lower menu.

For example: press **Signal Track** to enter directly.

5. Direct Execution



Execute the function after each press of the menu key.
For example: press **Peak->CF** to execute a peak search and the center frequency of the analyzer will be set to the frequency of the current peak signal.

6. Function Switch + Parameter Input



Press corresponding menu key to switch between functions; change parameter directly from the keyboard.
For example: press **CF Step** and switch between **Auto** and **Manual**; if select **Manual**, you can directly input desired numbers to change CF Step.

7. Selected State



Press corresponding menu key to modify parameter and return to the menu one level up.
For example: press **Trig Type** → **Free Run**, which indicates the analyzer is in Free Run state at the present.

Parameter Input

In this part, you will learn how to enter desired parameter values from the numerical keyboard, the knob, and the directional keys.

Numeric Keyboard



Figure 1-21 The Numerical keyboard

The numerical keyboard consists of:

1. Numerical keys

Numbers 0-9 are available to be used.

2. Decimal point

A decimal point "." will be inserted at the cursor position when this key is pressed.

3. Sign key

Sign key "+/-" is to toggle the sign of a parameter. When pressed the first time, a "-" will be inserted and changed into "+" following the second press.

4. Unit keys

Unit keys include GHz/dBm/s, MHz/dB/ms, kHz/dBmV/μs and Hz/mV/ns. After entering the desired numbers, choose an appropriate unit to complete the parameter input. The specific meaning of unit is decided by the type of current input parameter ("frequency", "amplitude" or "time").

5. Enter

When pressed, the system will complete the input process and insert a default measuring unit for the parameter automatically.

6. Esc

- (1) During parameter editing process this key can clear the inputs in the active area and exit editing mode at the same time.
- (2) Turn off the display of active area.
- (3) Exit current test mode while in keyboard test.
- (4) Unlock the screen while it is locked.

7. Back

- (1) During the process of parameter editing, this key will delete the characters on the left side of the cursor.
- (2) While in the process of file name editing, pressing this key will delete characters that have been entered.

Knob

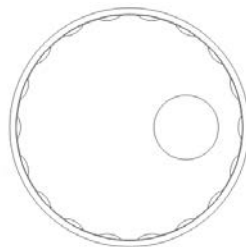

Figure 1-22 The knob

The knob has following functions:

1. During parameter editing, turn the knob clockwise to increase, or counterclockwise to decrease the parameter values at specified steps.
2. While editing a file name, the knob may select different characters from the soft keyboard.
3. Press **AMPT** → **Corrections** → **Edit**, and use the knob to select different reference points.

Direction key

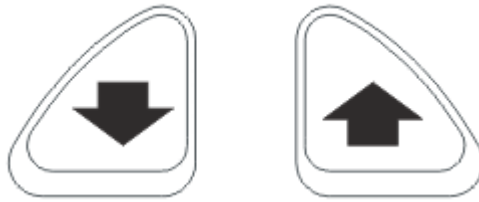

Figure 1-23 Direction keys

The directional keys have following functions:

1. Increase or decrease the parameter value at specific steps while editing a parameter.
2. Move the cursor among root directory in **Storage** function.
3. Select the character in the upper or lower row of the soft keyboard while editing file name.
4. Select the adjacent reference points in **Edit** menu: **AMPT** → **Corrections** → **Edit**.

Basic Measurement

In this section, we introduce how to use the analyzer to do basic measurements. Considering a 50 MHz, 0dBm sine wave signal produced from a generator (such as RIGOL DG3101A).



CAUTION

The signal amplitude (the frequency range is from 10 MHz to 3 GHz) must be less than 30 dBm (equal to 1 W), or else it will switch the input to a high power impedance state, and consequently the signal cannot be measured by the instrument.

Procedures:

1. Power on

2. Reset to factory settings

Press **System** → **Reset** → **Preset Type** → **Factory**, and then **Preset**. The instrument will reset all the parameters to factory settings.

3. Equipment Connection

Connect the signal output terminal of generator to the **RF INPUT 50Ω** terminal at the front panel of analyzer.

4. Setup the Center Frequency

- (1) Press **FREQ**, a corresponding menu will appear on the right of the screen, and **Center Freq** is in high-bright state, meanwhile, the center frequency parameter is shown at the top left corner of the display grid, which indicates the **Center Frequency** is active.
- (2) Center frequency could be changed through the numerical keyboard, the knob, or the directional keys.
- (3) Input **50** and select **MHz** as its unit using the numerical keyboard, then the center frequency of the analyzer is set to **50 MHz**.

5. Setup Span

- (1) Press **SPAN**, a corresponding menu will appear on the screen, and **Span** is in high-bright state, meanwhile, also the span parameter is shown at

- the top left corner of the display grid, which indicates **Span** is active.
- (2) Span value could be changed through the numerical keyboard, the knob, or the directional keys.
 - (3) Input **20** and select **MHz** as its unit using the numerical keyboard, then the span of the analyzer is set to **20 MHz**.

6. Setup Amplitude

- (1) Press **AMPT**, **Ref Level** is in high-bright state, the reference level will be shown at the top left corner of the display grid, which indicates **Reference Level** is active.
- (2) Reference level could be changed through the numerical keyboard, the knob, or the directional keys.
- (3) If necessary, you can change the reference level using the knob so as to bring the signal peak value near the top of the grid based on the signal display.

When all the steps above are finished, a 50 MHz RF curve will be shown on the analyzer.

7. Read Result

The value of frequency and amplitude could be read from the Marker. Press **Marker** → **Select Mkr** → **1** to activate Marker 1 and set the marker frequency to "50MHz", then the frequency and amplitude of where the marker is located would be shown at the upper right of the display grid.

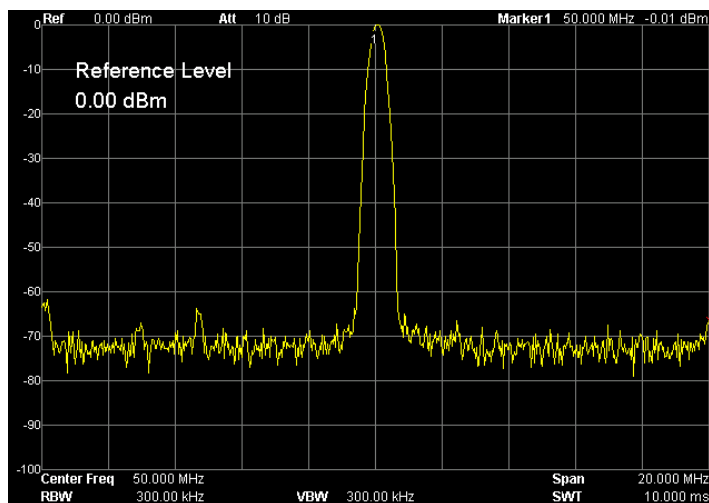

Figure 1-24 Measuring result

Ultra Spectrum

Ultra Spectrum is a PC application software developed by **RIGOL** for DSA1000&DSA1000A series spectrum analyzers. This software is designed based on the standard drive **VISA** commonly used in the industry. You can control the spectrum analyzer by using this PC software via **USB-TMC** or **LAN** interface. What's more, to fulfill various needs on signal measurement and signal study, Ultra Spectrum provides abundant data processing functions which are independent from the spectrum analyzer.

Main features of Ultra Spectrum:

- Enhance and expand instrument functions
- Realize data exchange between the instrument and PC
- Provide stronger data storage and process capability through PC

For detailed information about installation and use of Ultra Spectrum, refer to the related user's guide.

How to Use the Built-in Help

The built-in help provides information refers to every function key and menu key on the front panel. Users can view this help information if required.

1. How to acquire built-in help

Press **Help**; a prompt about how to obtain help information will be shown, then, repress the key related to the desired function, and the relevant information will be shown on the screen.

2. Page up and down

If there is more than one page of information, you can read the complete information by using the directional keys or the knob.

3. Close the current help information

Press any key on the front panel (except for up and down directional keys or the knob) to close the help.

4. Acquire the menu help

Press **Help**, a message about how to obtain help information will be shown, then, press the menu keys to get corresponding help.

5. Acquire the help information of any function key

Press **Help**, a message about how to obtain help information will be shown, then, press any function key to get corresponding help.

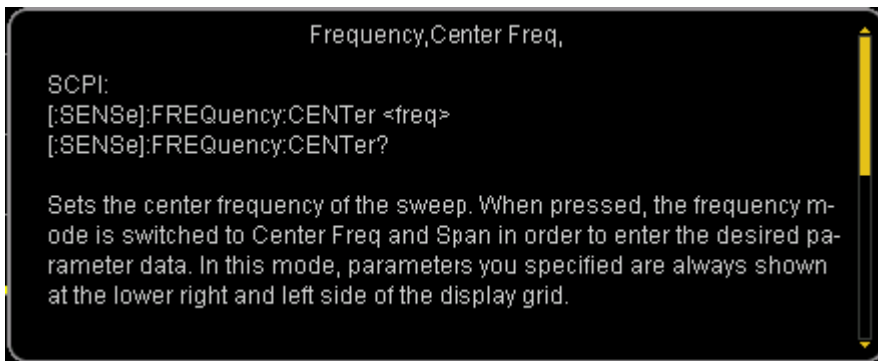

Figure 1-25 Built-in help

Chapter 2 Front Panel Key Reference

This chapter describes in detail the function keys on the front panel and associated pull down menus. Note that a third class title such as **O FREQ** always denotes a panel key of the analyzer, while a quaternary title such as **O Center Freq** always denotes a menu softkey of a panel key.

Subjects in this chapter:

- Basic Settings
- Sweep Settings
- Function Settings
- Advanced Measurements
- Marker Measurements
- System Functions
- Screen Control

Basic Settings

FREQ

Sets the frequency parameters of the analyzer. The analyzer sweeps within a specified frequency range, and the sweep is restarted every time you change this parameter.

The frequency range of a channel can be expressed by either of two groups of parameters: Start Frequency and Stop Frequency; or Center Frequency and Span. If any such parameter is changed, the others would be adjusted automatically in order to ensure the coupling relationship among them.

$$f_{center} = (f_{stop} + f_{start}) / 2 \quad (\text{Equation 2-1})$$

$$f_{span} = f_{stop} - f_{start} \quad (\text{Equation 2-2})$$

f_{center} , f_{stop} , f_{start} and f_{span} denotes the center frequency, the stop frequency, the start frequency and the span respectively.

Center Freq

Sets the center frequency of the sweep. When pressed, the frequency mode is switched to Center Freq and Span in order to enter the desired parameter data. In this mode, parameters you specified are always shown at the lower right and left side of the display grid.

Key Points:

- The start and stop frequencies vary with the center frequency when the span is constant.
- Changing the center frequency horizontally shifts the current sweep channel and the adjustment is limited by the specified frequency range.
- In Zero Span mode, the start frequency, stop frequency and center frequency are always equal. If one is changed the others are updated to match.
- You can modify this parameter using the numeric keys, knob, or direction keys. Refer to "**Parameter Input**" for more details.

Table 2-1 Center Frequency

Parameter	Explanation
Default	1.5 GHz
Range*	0 Hz to 3 GHz
Unit	GHz, MHz, kHz, Hz
Knob Step	Span > 0, step = Span/200 Span = 0, step = RBW/100 Min = 1 Hz
Direction Key Step	CF step

Note*: The range is from 50 Hz to (3 GHz-50 Hz) in non-zero span.

Start Freq

Sets the start frequency of the sweep. When pressed, the frequency mode is switched to Start Freq and Stop Freq in order to enter the desired parameter data. In this mode, parameters you specified are always shown at the lower left and right side of the grid.

Key Points:

- The span and center frequency are changed automatically according to the start frequency. The change of the span would have influence on other system parameters. For more details, please refer to “**Span**”.
- In Zero Span mode, the start frequency, stop frequency and center frequency are always equal. If one is changed the others are updated to match.
- You can modify this parameter using the numeric keys, knob, or direction keys. Refer to “**Parameter Input**” for more details.

Table 2-2 Start Frequency

Parameter	Explanation
Default	0 Hz
Range*	0 Hz to 3 GHz
Unit	GHz, MHz, kHz, Hz
Knob Step	Span > 0, step = Span/200 Span = 0, step = RBW/100 Min = 1 Hz
Direction Key Step	CF step

Note*: The range is from 0 Hz to (3 GHz-100 Hz) in non-zero span.

Stop Freq

Sets the stop frequency of the sweep. When pressed, the frequency mode is switched to Start Freq and Stop Freq in order to enter the desired parameter data. In this mode, parameters you specified are always shown at the lower left and right side of the grid.

Key Points:

- Modifying the stop frequency changes the span and center frequency, and the change of span influences other system parameters, see "**Span**".
- You can modify this parameter using the numeric keys, knob or direction keys. For more details, please refer to "**Parameter Input**".

Table 2-3 Stop frequency

Parameter	Explanation
Default	3 GHz
Range*	0 Hz to 3 GHz
Unit	GHz, MHz, kHz, Hz
Knob Step	Span > 0, step = Span/200 Span = 0, step = VBW/100 Min = 1 Hz
Direction Key Step	CF step

Note*: The range is from 100 Hz to 3 GHz in non-zero span.

Freq Offset

You can set a frequency offset to explain the frequency conversion between the device under test and the spectrum analyzer input.

Key Points:

- This parameter will not affect any hardware setting. It only changes the displayed values of the center frequency, start frequency and stop frequency.
- You can modify this parameter using the numeric keys, knob or direction keys. For more details, please refer to "**Parameter Input**".
- If you want to cancel the frequency offset, you can perform the Preset operation or set the frequency offset to 0 Hz.

Table 2-4 Frequency offset

Parameter	Explanation
Default	0 Hz
Range	-100 GHz to 100 GHz
Unit	GHz, MHz, kHz, Hz
Knob Step	15 MHz
Direction Key Step	CF step

CF Step

Sets the step of center frequency. Changing the center frequency in a fixed step continuously switches the channel to be measured.

Key Points:

- The CF step type could be “Manual” or “Auto”. In Auto mode, the CF step is 1/10 of span if it is in Non-zero span mode or equals the RBW while in Zero span mode; in Manual mode, you can set the step using the numeric keys.
- After you set an appropriate CF step and select center frequency, you can use the up and down direction keys to switch between measurement channels in the specified step in order to sweep the adjacent channels manually.
- You can modify this parameter using the numeric keys, knob, or direction keys. For more details, please refer to “**Parameter Input**”.

Table 2-5 CF step

Parameter	Explanation
Default	300 MHz
Range	1 Hz to 3 GHz
Unit	GHz, MHz, kHz, Hz
Knob Step	Span > 0, step = Span/200 Span = 0, step = 100 Hz Min = 1 Hz
Direction Key Step	in 1, 2, 5 sequence

CF Step Application

You can use the CF step function to detect the harmonic waves and sidebands that are beyond the current span.

For example, for each order of harmonic of a 100 MHz signal, you can set both the center frequency and CF step to 100 MHz and press the down direction key continuously to show each order of harmonic successively at the center of the screen.

Signal Track

Tracks signals with unstable frequency and less than 3 dB transient variation in amplitude by placing the Marker1 (see “**Marker Measurements**”) onto the measured signal to track the variation continuously.

The system tracks a signal according to the following steps:

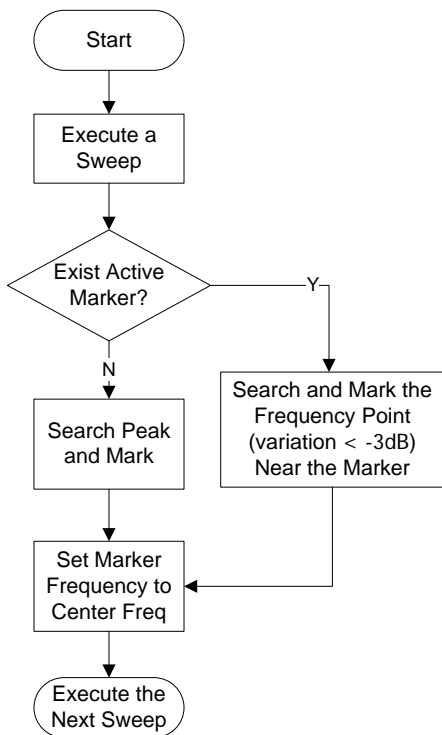



Figure 2-1 Process of signal tracking

Key Points:

- When Signal Track is On, the ST (Signal Track) icon  is shown at the left of screen.
- If an active marker currently exists, when Signal Track is enabled, the instrument will search and mark the point (with no more than 3 dB variation in amplitude) near the marker, set the frequency of this point as center frequency and hold the signal at the center of the screen.
- If no marker is active, when Signal Track is enabled, the instrument will activate Marker 1, execute a peak searching automatically, set the frequency of the current peak as center frequency and hold the signal at the center of the screen.
- In Continue sweep, the system tracks continuously; in Single sweep, only one track is done; in Zero Span, Signal Track is invalid.

Peak -> CF

Executes a peak search and uses the frequency of current peak as the center frequency of the analyzer. The function is invalid in Zero Span mode.

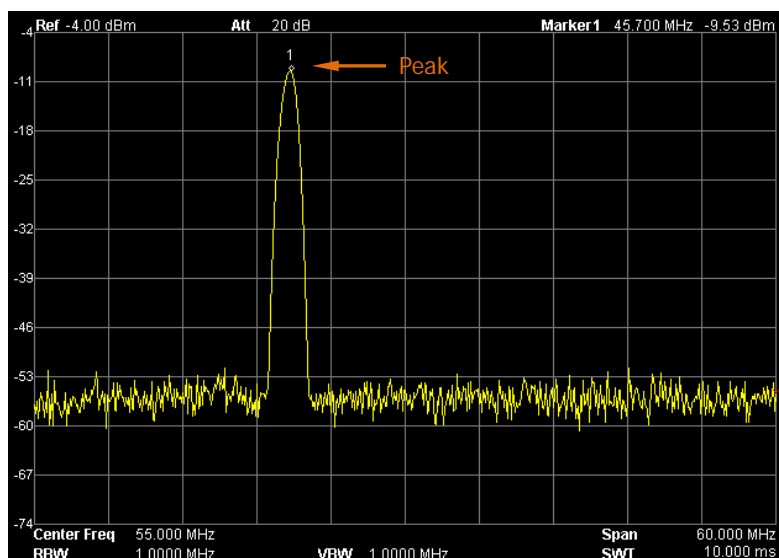

Figure 2-2 Before the Peak->CF

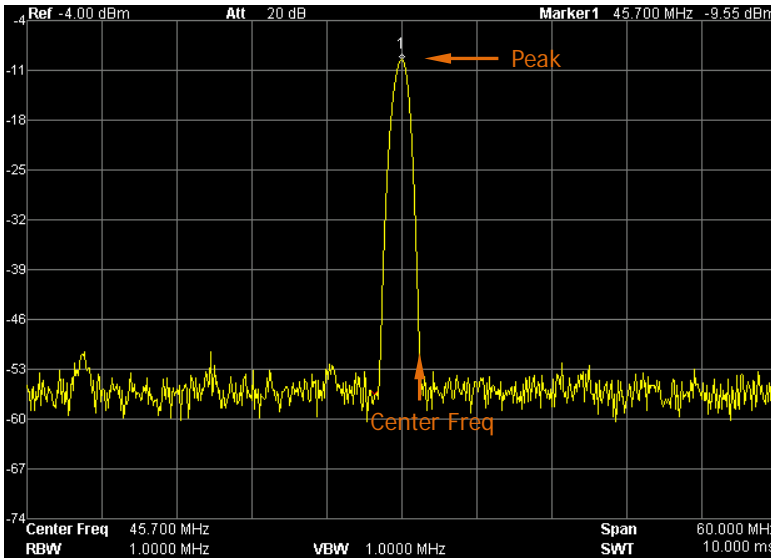

Figure 2-3 After the Peak->CF

CF -> Step

Sets the current center frequency as the CF step. This function is usually used with channel switching. Take harmonic waveform measurements for example: locate a signal at the center frequency of a channel, execute **CF-> Step** and then continuously press the down direction key to measure each order of harmonic in sequence.

SPAN

Sets the span value of the analyzer. The changing of this parameter will affect other parameters associated with the **FREQ** function, and restart the sweep.

Span

Sets the frequency range of the sweep. When pressed, the frequency mode is switched to Center Freq and Span in order to enter the desired parameter data. In this mode, parameters you specified are always shown at the lower left and right sides of the display grid.

Key Points:

- The start and stop frequencies are changed with the span automatically.
- In manual span mode, the span can be set down to 100 Hz (the only way into the zero-span mode is to press the **Zero Span** menu option) and up to the full span described in "**Specification**".
- Modifying the span in non-zero span mode may cause an automatic change in both CF step and RBW if they were in Auto mode, and the change of RBW may influence VBW (in Auto VBW mode).
- In non-zero span mode, variation in the span, RBW or VBW would cause a change in sweep time.
- In non-zero span mode, neither "Video" trigger nor "1/ Δ time" readout function is valid.
- You can modify this parameter using the numeric keys, knob, or direction keys. For more details, please refer to "**Parameter Input**".

Table 2-6 Span

Parameter	Explanation
Default	3 GHz
Range*	0 Hz to 3 GHz
Unit	GHz, MHz, kHz, Hz
Knob Step	Span/200, Min = 1 Hz
Direction Key Step	in 1, 2, 5 sequence

Note*: 0 Hz is available only in zero span.

Full Span

Sets the span of the analyzer to the maximum.

Zero Span

Sets the span of the analyzer to 0 Hz. Both the start and stop frequencies will equal the center frequency and the horizontal axis will denote time. The analyzer here is measuring the time domain characteristics of amplitude, located at the corresponding frequency point.

Key Points:

As opposed to the Non-zero span, the screen shows the time domain characteristics of the fixed frequency component, and following functions are invalid in Zero span mode:

- **FREQ**: Peak->CF, Signal Track and Channel setting;
- **SPAN**: Zoom In and Zoom Out;
- **Marker->**: Mkr->CF, Mkr->Step, Mkr->Start, Mkr->Stop, Mkr Δ ->CF and Mkr Δ ->Span;
- **Marker**: Readout \rightarrow Frequency, Period and $1/\Delta$ Time (valid in Delta marker type)

Zoom In

Sets the span to the half of its current value (down to the minimum).

Zoom Out

Sets the span to twice the current value (up to the maximum).

Last Span

Changes the span to the previous span setting.

AMPT

Sets the amplitude parameters of the analyzer. Through these parameters, signals under measurement can be displayed at an optimal view with minimum error.

Auto Scale

This setting enables the readout resolution of the current Y-axis to be the maximum possible on condition that the whole signal is within the screen. When enabled, the system sets the reference level automatically in order to place the peak of signal within the topmost grip.

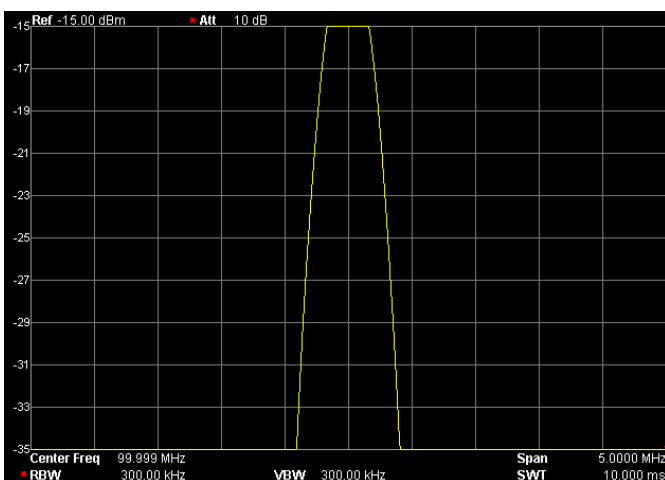

Figure 2-4 Before the Auto Scale

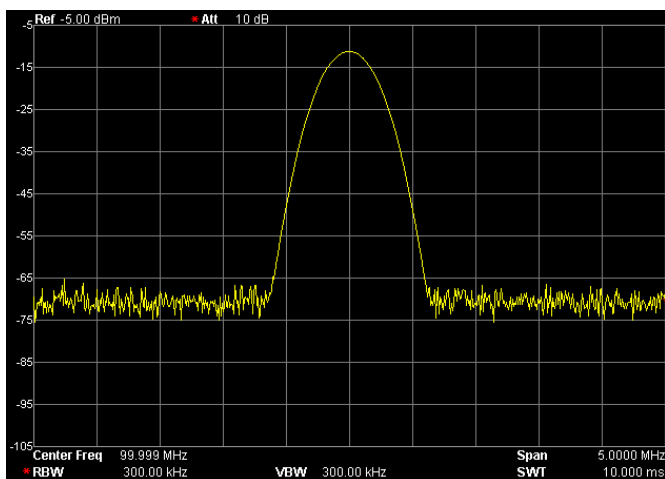

Figure 2-5 After the Auto Scale

Ref Level

Sets the maximum power or voltage to be displayed at the upper left of the display grid.

Key Points:

- This value is affected by a combination of maximum mixing level, input attenuation, and preamplifier. When you adjust it, the input attenuation is adjusted under a constant max mixing level, meeting:

$$L_{Ref} - a_{RF} + a_{PA} \leq L_{mix} \quad (\text{Inequality 2-3})$$

L_{Ref} , a_{RF} , a_{PA} and L_{mix} denotes the reference level, the input attenuation, the preamplifier, and the max mixing level, respectively.

- You can modify this parameter using the numeric keys, knob, or direction keys. For more details, please refer to "**Parameter Input**".

Table 2-7 Reference level

Parameter	Explanation
Default	0 dBm
Range	-100 dBm to 30 dBm
Unit	dBm, -dBm, mV, uV
Knob Step	in Log scale mode, step = Scale/10 in Lin scale mode, step = 0.1 dB
Direction Key Step	in Log scale mode, step = Scale in Lin scale mode, step = 1 dBm

Input Atten

Sets the front attenuator of the RF input in order to permit big signals (or small signals) to pass from the mixer with low distortion (or low noise).

Key Points:

- When the preamplifier is On, the input attenuation could be set up to 30 dB. You can adjust the reference level to ensure that the specified parameters

meet the inequality in formula 2-3 (above).

- You can modify this parameter using the numeric keys, knob, or direction keys. For more details, please refer to **“Parameter Input”**.

Table 2-8 Input attenuation

Parameter	Explanation
Default	10 dB
Range	0 dB to 50 dB
Unit	dB
Knob Step	5 dB
Direction Key Step	5 dB
Keyboard Step	1 dB

Scale/Div

Sets the logarithmic units per vertical grid division on the display.

Key Points:

- By changing the scale, the displayed amplitude range is adjusted.
- The amplitude that can be displayed is from reference level minus 10 times the current scale value to the reference level.
- You can modify this parameter using the numeric keys, knob, or direction keys. For more details, please refer to **“Parameter Input”**.

Table 2-9 Scale

Parameter	Explanation
Default	10 dB
Range	0.1 dB to 20 dB
Unit	dB
Knob Step	Scale ≥ 1 , step = 1 dB Scale < 1 , step = 0.1 dB
Direction Key Step	in 1, 2, 5 sequence

Scale Type

Sets the Scale Type of Y-axis to Lin or Log, the default is Log.

Key Points:

- In Log scale type: the Y-axis denotes the logarithmic coordinates, the value shown at top of the grid is the reference level and the grid size is equal to the scale value. The unit of Y-axis will be automatically switched into the default "dBm" when the scale type is changed from Lin to Log.
- In Lin scale type: the Y-axis denotes the linear coordinates, the value shown at the top of the grid is the reference level and the bottom of the grid shows 0 V. The grid size is 10% of the Reference level and the Scale/Div is invalid. The unit of Y-axis will be automatically switched into the default "Volts" when the scale type is changed from Log to Lin.
- Other than as mentioned above, the unit of Y-axis is independent of the Scale Type.

Units

Sets the unit of the Y-axis to dBm, dBmV, dBuV, Volts or Watts. The units dBm, dBmV, and dBuV are for Log scaling; Volts and Watts are for Linear scaling. The default is dBm.

Key Points:

See relationships between units:

$$dBm = 10\log\left(\frac{Volts^2}{R} \times \frac{1}{0.001W}\right) \quad (\text{Equation 2-4})$$

$$dB\mu V = 20\log\left(\frac{Volts}{1\mu V}\right) \quad (\text{Equation 2-5})$$

$$dBmV = 20\log\left(\frac{Volts}{1mV}\right) \quad (\text{Equation 2-6})$$

$$Watts = \frac{Volts^2}{R} \quad \text{(Equation 2-7)}$$

Where, R denotes the reference resistance.

Ref Offset

Assigns an offset to the reference level to attempt to compensate for gains or losses generated between the device under measurement and the analyzer.

Key Points:

- The changing of this value changes both the readout of the reference level and the amplitude readout of the marker, but will not impact the position of the curve on the screen.
- You can modify this parameter using the numeric keys. For more details, please refer to "**Parameter Input**".

Table 2-10 Reference level offset

Parameter	Explanation
Default	0 dB
Range	-300 dB to 300 dB
Unit	dB
Knob Step	N/A
Direction Key Step	N/A

Auto Range

Adjusts the amplitude parameters within the specified span range automatically in order to display the whole signal optimally on the grid.

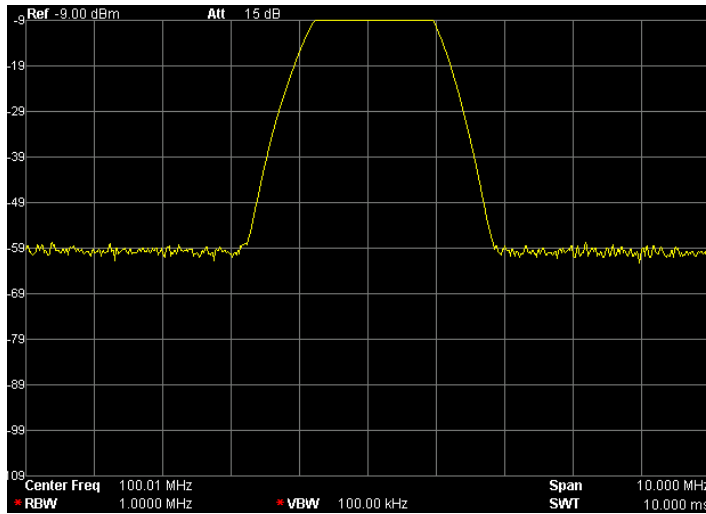

Figure 2-6 Before the Auto Range

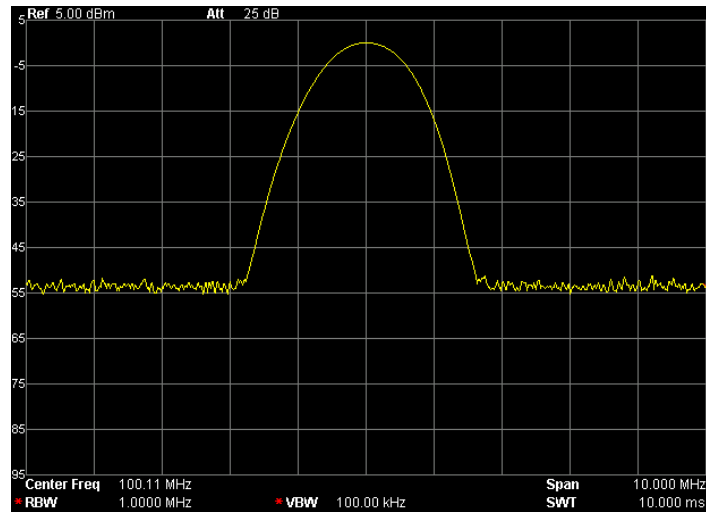

Figure 2-7 After the Auto Range

Key Points:

- Unlike Auto Scale, this function can solve the problem of an overrange measurement due to parameter settings and adjust the max mixing level

based on the signal under measurement.

- Unlike Auto Tune, this function is focused on the signal within the current channel and will not make any changes to the channel frequency, while, Auto Tune will search for signals within the full band frequency and adjust the displayed frequency so the detected signals are at the center frequency.

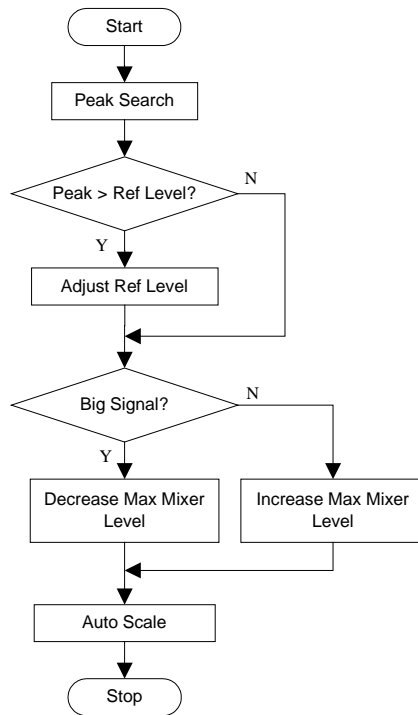



Figure 2-8 Process of the Auto Range

RF Preamp

Sets the status of preamplifier located at the front of the RF signal path. Turning on the preamplifier reduces the displayed average noise level in order to distinguish small signals from the noise when working with small signals.

Key Points:

An icon  will be displayed on the left of screen when the preamplifier is **On**.

Correction

Corrects the amplitude in order to compensate for the gain or loss from peripheral equipment such as Antenna, Cable, and so on. When using this function, you can view the correction parameters through a table and save or load the correction factors during editing. When Correction is On, both the trace and related measurement results will be corrected, and an icon  is shown on the left of screen.

1. Select

Chooses a correction factor from Antenna, Cable, Other or User for the current correction. All related frequency and amplitude corrections will be displayed to compensate for external gains or losses, the default is Off.

2. Correction

Enables or disables the amplitude correction, the default is Off. When you enable the Correction, the system starts correcting the amplitude with a specified factor. If more factors are added, all related data will be used for amplitude correction.

3. Edit

Sets or modifies the frequency and amplitude of correction factor. You can modify this parameter using the numeric keys, knob, or direction keys. See table below:

Table 2-11 Edit menus of Amplitude correction

Menu	Explanation
Point	Create or set desired data point for correction factor Range: 1 to 200
Frequency	Set the frequency of specified point
Amplitude	Set the amplitude correction of specified point Range: -120 dB to 100 dB
Del Point	Delete the specified point data: frequency and amplitude correction.

4. Freq Interp

Selects the correction type to Lin or Log. In type of Lin, the frequency and

amplitude separately uses a Lin and Log unit to do interpolation; in type of Log, both of parameters use a Log unit.

5. Delete

Clears the frequency and amplitude correction data of the selected factor.

6. Corr Table

Turns on or off the edited correction table. At this moment, the screen is divided into two parts, the upper shows the measurement curve and the lower shows the edited points, frequency, and amplitude.

7. Corr View

- All: view the data for all correction factors.
- Sel: view the data for selected correction factor.

MaxMixL

Sets the max input level of mixer according to the magnitude of signal.

Key Points:

- For a bigger input signal, choosing a smaller max mixing level can increase the input attenuation and reduce the distortion of the signal; for a smaller input signal, choosing a bigger max mixing level can reduce the input attenuation and noise.
- Parameters in Inequality 2-5 are always changing on the basis of the max mixing level.
- You can modify this parameter using the numeric keys, knob, or direction keys. For more details, please refer to "**Parameter Input**".

Table 2-12 Max mixing level

Parameter	Explanation
Default	-10 dBm
Range	-50 dBm to 0 dBm
Unit	dBm, -dBm, mV, uV
Knob Step	1 dBm
Direction Key Step	10 dBm

Input

Sets the input impedance for voltage-to-power conversions (see Equation 2-4). The default is 50Ω. To measure a 75Ω device, you should use a 75Ω to 50Ω adapter supplied by **RIGOL** to connect the analyzer with the system under test and then set this menu to 75 Ω.

Note: A “75 Ω” sign will be shown in the status bar of the screen in this situation.

Sweep Settings

BW

Sets the RBW (Resolution Bandwidth) and VBW (Video Bandwidth) parameters of the analyzer.

RBW

Sets the desired resolution bandwidth in order to distinguish between signals which are close in frequency.

Key Points:

- Reducing the value of RBW will increase the frequency resolution, but may also cause sweeps to take longer (Sweep Time is effected by a combination of RBW and VBW when it is in Auto mode).
- RBW decreases with the span (non-zero span) in Auto RBW mode.

Note: if detector type is "Quasi-Peak" or filter type is "EMI", RBW can be 200 Hz, 9 kHz, 120 kHz or 1 MHz only.

Table 2-13 RBW

Parameter	Explanation
Default	1 MHz
Range	10 Hz to 1 MHz
Unit	GHz, MHz, kHz, Hz
Knob Step	in 1, 3, 10 sequence
Direction Key Step	in 1, 3, 10 sequence

VBW

Sets the desired video bandwidth in order to remove the band noise.

Key Points:

- Reducing the VBW to smooth the spectrum line and differentiate small signals from the noise. However, this may cause a longer sweep time. (Sweep Time is

effected by a combination of RBW and VBW when it is in Auto mode).

- VBW varies with RBW when it is set to Auto.

Table 2-14 VBW

Parameter	Explanation
Default	1 MHz
Range	1 Hz to 3 MHz
Unit	GHz, MHz, kHz, Hz
Knob Step	in 1, 3, 10 sequence
Direction Key Step	in 1, 3, 10 sequence

V/R Ratio

Sets the ratio of VBW to RBW.

Key Points:

- This value is different while measuring different kinds of signals:
 - Sine signal: use 1 - 3 (for faster sweeps)
 - Pulse signal: use 10 (to reduce the influence on the amplitude of transient signals)
 - Noise signal: 0.1 is perfect (to obtain an average of noises)
- You can modify this parameter using the numeric keys, knob, or direction keys. For more details, please refer to "**Parameter Input**".

Table 2-15 V/R Ratio

Parameter	Explanation
Default	1
Range	0.0000010 to 300000.00
Unit	N/A
Knob Step	in 1, 3, 10 sequence
Direction Key Step	in 1, 3, 10 sequence

Filter Type

Set RBW filter type.

Key Points:

- DSA1000A supports two kinds of RBW filters: "Gauss" (-3 dB bandwidth) and "EMI" (-6 dB bandwidth).
- When "EMI" is selected, resolution bandwidth can be 200 Hz, 9 kHz, 120 kHz or 1 MHz only.
- The default is "Gauss"; the instrument will switch to "EMI" filter automatically when "Quasi-Peak" detector is selected.

Sweep

Sets parameters about the Sweep function, including Time, Auto SWT, Mode, Numbers and Points.

Time

Sets the time interval for the analyzer to complete a sweep. Either Auto or Manual can be used, the default is Auto.

Key Points:

- In non-zero span, the analyzer uses the shortest sweep time on the basis of the current RBW and VBW settings if Auto is selected.
- Decreasing the sweep time would speed the measurement. However, an error may be caused if the specified time is less than the minimum duration in Auto coupling, and "UNCAL" is shown at the status bar of the screen.
- You can modify this parameter using the numeric keys, knob, or direction keys. For more details, please refer to "**Parameter Input**".

Table 2-16 Sweep time

Parameter	Explanation
Default	100 ms
Range*	20 us to 3000 s
Unit	ks, s, ms, us, ns, ps
Knob Step	Sweep time/100, Min = 1 ms
Direction Key Step	in 1, 1.5, 2, 3, 5, 7.5 sequence

Note*: The minimum in non-zero span mode is 10 ms.

Auto SWT

Sets the auto type of the sweep time to Normal or Accy. The sweep will be faster if you select Normal; while in Accy type, higher measurement precision can be obtained.

Mode

Sets the sweep mode to Single or Continue, the default is Continue. If you select Single, the backlight of **Single** located on the front panel turns on, and so does the backlight of **Continue** when Continue is selected. The corresponding parameters and type icons are shown on the left side of screen.



Continue: the character **Cont** from the parameter icon is the abbreviation of the Continue, which denotes the analyzer is sweeping continuously.

Single: the number **10** from the parameter icon denotes the current sweep number.

Numbers

Sets the number of times for a single sweep. In Single mode, the system executes specified sweeps. The number shown on the left status icon of the screen varies with the process of sweep.

Table 2-17 Numbers

Parameter	Explanation
Default	1
Range	1 - 9999
Unit	N/A
Knob Step	1
Direction Key Step	1

Points

Sets the desired points for every sweep. That is the number of points of the current trace.

Key Points:

- Changing the points may influence the sweep time which is limited by the

sample rate of the ADC (Analog to Digital Converter). That is, the more points used, the longer the sweep will be.

- Changing the points would also influence other system parameters, thus the system restarts the sweep and measurement cycle.
- You can modify this parameter using the numeric keys, knob or direction keys. For more details, please refer to "**Parameter Input**".

Table 2-18 Points

Parameter	Explanation
Default	601
Range	101 to 3001
Unit	N/A
Knob Step	1
Direction Key Step	100

Hint

- The sweep points will automatically change to the maximum (3001) and the menu is grayed out and disabled in **Video** trigger type.
- With the increase (more than 601) of sweep points, the frequency resolution of marker points increases and the sweep speed decreases.
- In addition to the sweep points, other parameters such as span, resolution bandwidth, video bandwidth, average detection method, and center frequency can also influence the sweep speed.

Auto Tune

Searches for signals automatically throughout the full frequency range, adjusts the frequency and amplitude to their optimum and realizes one-key signal search and auto setting of parameters.

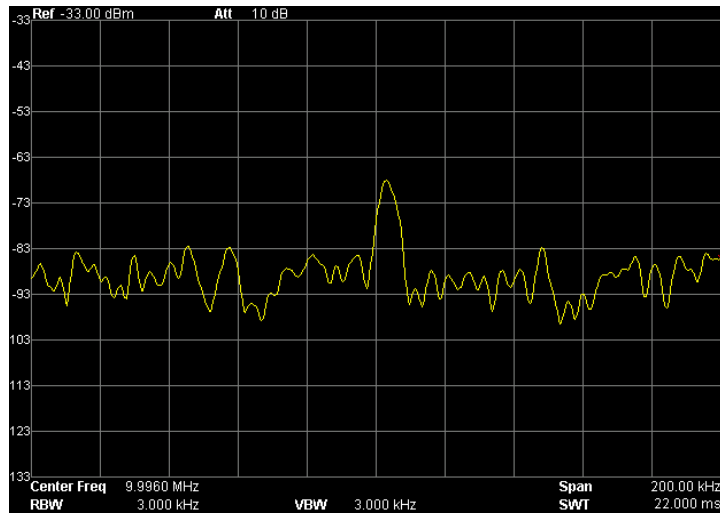

Figure 2-9 Before the Auto Tune

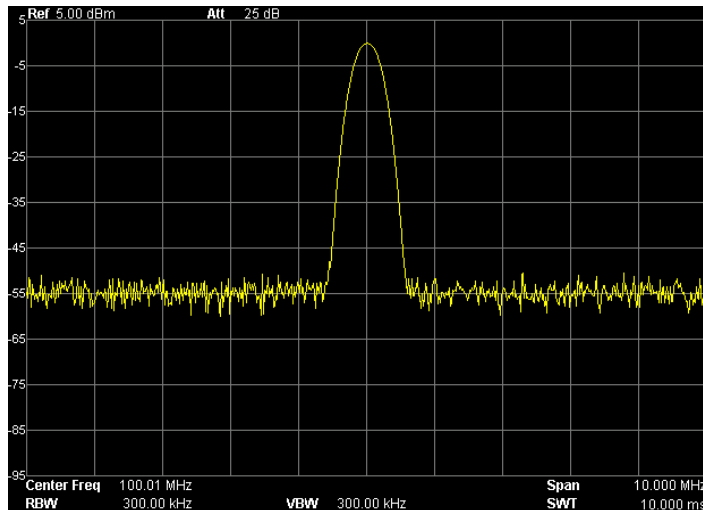

Figure 2-10 After the Auto Tune

Key Points:

- In the process of searching, the backlight of **Auto Tune** turns on and “Auto Tune” is shown on the status bar of the screen until the search is finished.
- In Auto mode, press **Auto Tune** to stop the search.
- The magnitude of some parameters such as reference level, scale, input attenuation, and max mixing level may be changed during the auto tune.

Trig

Sets the trigger type and other associated parameters.

Trig Type

The trig type can be Free Run, Video or External. In each type of Trig, there will be a related parameter icon shown on the left of screen such as:



1. Free Run

This indicates all trigger conditions can be satisfied at any time and the analyzer generates trigger signals continuously.

2. Video

This indicates a trigger signal will be generated when the system detects a video signal in which the voltage exceeds the specified video trigger level.

This function is invalid in one of the three conditions which are non-zero span mode, RMS Avg detection and Voltage Avg detection.

3. External

In this mode, an external signal (TTL signal) is input from the **[TRIGGER IN]** connector at the rear panel, of which the edge conditions should meet with the user settings to generate trigger signals.

Trig Setup

1. Trigger Level

Sets the trigger level in Video mode. The screen will display corresponding line TL and the value of it after you finish the setting. The numeric keys, knob or direction keys is available for level modification, please refer to **"Parameter Input"** for more details.

Table 2-19 Trigger level

Parameter	Explanation
Default	0 dBm
Range	-300 dBm to 50 dBm
Unit*	dBm
Knob Step	1 dBm
Direction Key Step	10 dBm

Note*: This is in connection with the specified unit of Y-axis.

2. Edge

Sets the trigger edge to Positive or Negative.

Single

Sets the sweep mode to Single.

Key Points:

- If it is in Continue sweep mode and no measurement function is enabled, pressing this key will enter the Single sweep mode and execute specified number of sweeps on the condition that all trigger conditions are satisfied.
- If it is in Continue sweep mode and a measurement function is on, pressing this key will enter the Single measure mode and execute specified number of measurements on the condition that all trigger conditions are satisfied.
- If the system is already in Single sweep mode, pressing this key will execute specified number of sweeps (or measurements) on the condition that all trigger conditions are satisfied.
- In Single sweep mode, trigger initialization (pressing **Single** or sending an INIT command through the remote interface) should be executed before you judge the trigger condition.

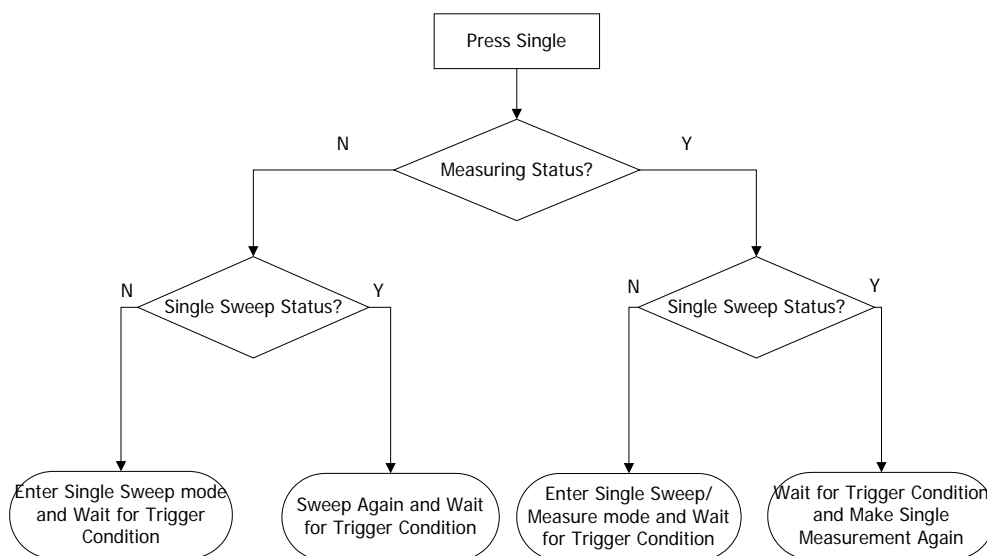

Figure 2-11 Process of a single sweep

Continue

Sets the sweep mode to Continue.

Key Points:

- If the instrument is in Single sweep mode and no measurement function is enabled, pressing this key will enter the Continue mode and execute specified number of sweeps on the condition that all trigger conditions are satisfied.
- If the instrument is in Single sweep mode and a measurement function is on, pressing this key will enter the Continue sweep mode and execute specified number of measurements on the condition that all trigger conditions are satisfied.
- In Continue mode, the system will send a trigger initialization signal automatically and enter the trigger condition judgment directly.

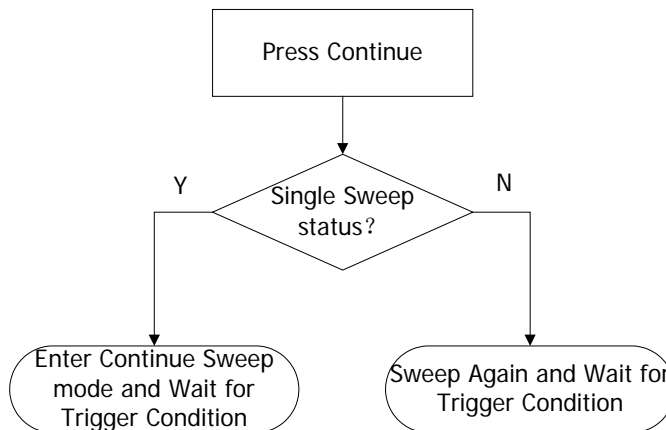

Figure 2-12 Process of continue sweep

Function Settings

Detector

While displaying a wider span, each pixel contains spectrum information associated with a larger subrange. That is, several samples may fall on one pixel. Which of the samples will be represented by the pixel depends on the selected detector type. See the working principle of the detector below:

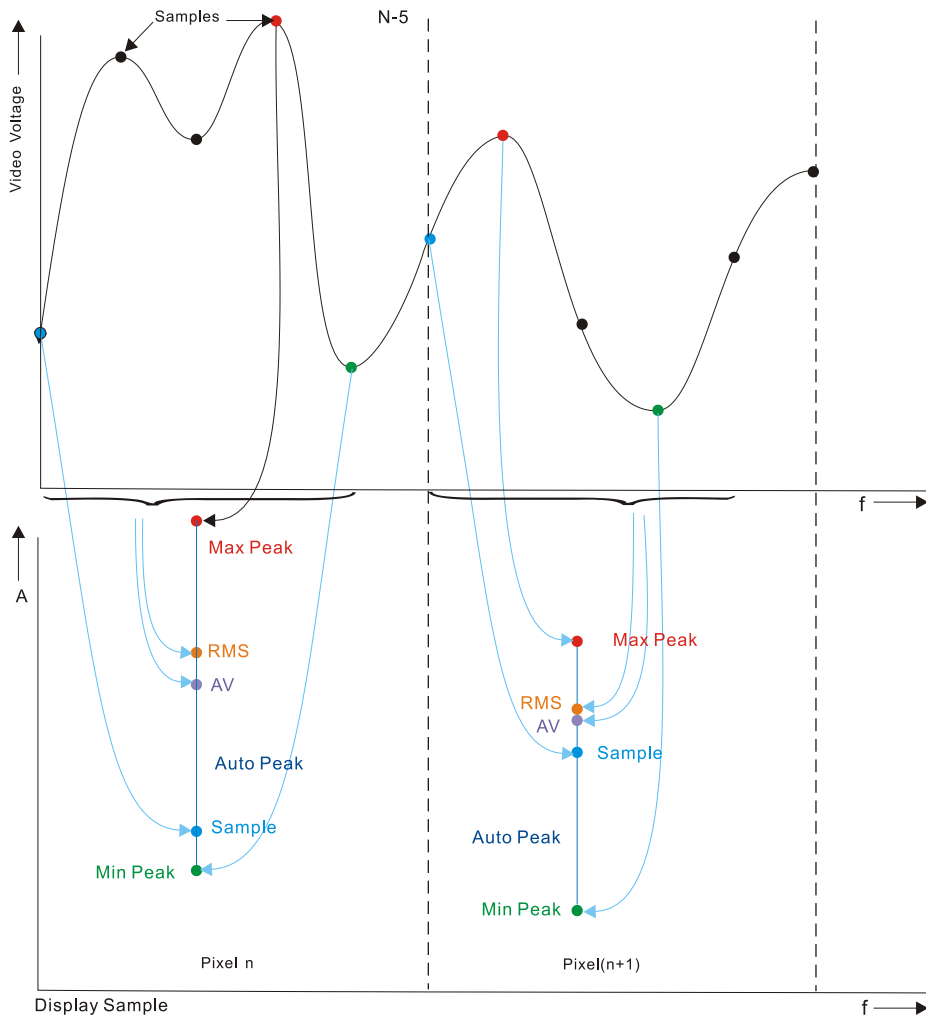

Figure 2-13 Working principle of the detector

Key Points:

- Selects an appropriate type according to the application in order to ensure the accuracy of the measurement for your application.
- The available types are: Pos Peak, Neg Peak, Sample, Normal, RMS Avg, Voltage Avg and Quasi-Peak, the default is Pos peak.
- Every selected type is shown with a parameter icon on the left status bar of screen, see below:



Pos Peak

Searches the maximum from the sampling data segment and displays it at the corresponding pixel.

Neg Peak

Searches the minimum from the sampling data segment and displays it at the corresponding pixel.

Sample

Chooses any point data from the sampling data segment and displays at the corresponding pixel.

Normal

Searches both the minimum and maximum from the sampling data segment and displays them at the corresponding pixel. In this type, you can observe the rangeability of a signal in real time.

RMS Avg

Calculates the data from the sampling data segment with mean square root operation (see equation below) and displays the result as a pixel. In this type, noise can be rejected and weak signals can be clearly observed.

$$V_{RMS} = \sqrt{\frac{1}{N} \times \sum_{i=1}^N v_i^2} \quad (\text{Equation 2-8})$$

Where V_{RMS} = RMS value of voltage, in V

N = number of samples assigned for every pixel

v_i = envelop of the samples, in V

The reference resistance R can be used for calculating the power:

$$P = \frac{v_{RMS}^2}{R}$$

Voltage Avg

Averages all the data from the sampling segment (see equation below) and displays the result as a pixel.

$$V_{AV} = \frac{1}{N} \times \sum_{i=1}^N v_i \quad (\text{Equation 2-9})$$

Where V_{AV} = average of voltage, in V

N = number of samples assigned for every pixel

v_i = envelop of the samples, in V

Quasi-Peak

It is a weighted form of peak detector. For each data point, the detector detects the peaks within the corresponding time interval. The peaks detected are weighted using circuit with specified charge and discharge structures as well as the display time constant specified in the CISPR Publication 16 standards and the result is displayed. Quasi-Peak detector is applicable to EMI testing.

Note: compared to the discharge time, the charge time of Quasi-Peak detector is much shorter and can reflect the amplitude as well as time distribution of the signal.

Trace

As the sweep signal is displayed as a trace on the screen, you can set parameters about the trace using this key. The analyzer allows for up to four traces to be displayed at one time, and each trace has its own color (Trace 1 - yellow, Trace 2 - purple, Trace 3 – light blue and Trace 4 - green). All traces can be set freely except Trace 4 (a math operation trace that can only be obtained using the other three traces).

Select Trace

Selects Trace 1, Trace 2 or Trace 3 in order to set the corresponding parameters. By default, Trace 1 is selected and enabled and the trace type is "Clear Write".

Trace Type

Sets the type of the current trace or disables it. The system makes calculations of the sample data according to the trace type selected and displays the result. The trace type can be Clear Write, Max Hold, Min Hold, Video Avg, Power Avg, Freeze or Blank. Every type has its own parameter icon that is shown on the left of screen. Take Trace 1 (yellow) as an example and the icons are as shown in the figures below.



1. Clear Write

Sets the trace data to the minimum and the value of each point is the data acquired from the real-time sample.

2. Max Hold

Maintains the maximum for each point of the trace, and updates each trace point if a new maximum is generated in successive sweeps.

3. Min Hold

Maintains the minimum for each point of the trace, and updates each trace point if a new minimum is generated in successive sweeps.

4. Video Avg

Displays the logarithmic average for each point of the trace. Traces in this type are smoother.

5. Power Avg

Display the average of each point of the trace. Traces in this type are smoother.

6. Freeze

Stops updating trace data in order to observe the trace and read the measurement data. This type is generally used by traces loaded from storage devices or remote interface as default.

7. Blank

Disables the trace display and all measurements based on this trace.

Average Times

Sets the number of averages of the selected trace.

Key Points:

- More averages can reduce the noise and the influence of other random signals, thus highlighting the stable signal characteristics. The larger the number of averages is, the smoother the trace will be.
- You can use the numeric keys to modify this parameter. Please refer to “**Parameter Input**” for more details.

Table 2-20 Number of averages

Parameter	Explanation
Default	100
Range	1 to 1000
Unit	N/A
Knob Step	N/A
Direction Key Step	N/A

Trace Math

1. Function

Sets the computational method of the math trace.

- A-B: subtracts Trace B from A
- A+Constant: adds a constant to Trace A
- A-Constant: subtracts a constant from Trace A

2. A

Assigns a value to A from Trace1, Trace 2 or Trace 3. The default is Trace 1.

3. B

Assigns a value to B from Trace 1, Trace 2 or Trace 3. The default is Trace 2.

4. Constant

Sets the value of the constant.

You can use the numeric keys to modify this parameter. Please refer to “**Parameter Input**” for more details.

Table 2-21 Constant in math operation

Parameter	Explanation
Default	0 dB
Range	-300 dB to 300 dB
Unit	dB

5. Operate

Enables or disables the display of the math trace. The default is Off.

Note: This menu is valid only when A or B in the expression of the math trace is set to the selected type of trace.

Blank All

Turns off all the traces displayed on the screen. This operation may stop the current advanced measurement as there is no available data source.

AVG Reset

Re-calculates the trace average.

Note: This function is only available when the trace type is set to “Video Avg” or “Power Avg”.

Demod

Sets the demodulation of the analyzer. Both AM and FM are available in this device.

Demod

Sets the demodulation type to AM, FM, or Off, the default is Off.

Key Points:

- The system will enable a marker automatically and place it at the center frequency for AM (or FM) demodulation after you open AM (or FM).
- You can activate the speaker to output the modulation signal through an audio frequency (AF). The frequency and intensity of the audio respectively denotes the frequency and intensity of the modulation signal.

Demod Setup

1. Speaker

Sets the status of internal speaker. When it is On, you can hear the signal during demodulation, the default is Off.

2. Volume

Sets the volume of the speaker.

Table 2-22 Volume

Parameter	Explanation
Default	100
Range	0 to 255
Unit	N/A
Knob Step	10
Direction Key Step	20

3. Demod Time

Sets the time interval for the analyzer to complete a signal demodulation after each sweep. If the speaker is On, you will hear sound during the

demodulation.

You can use the numeric keys, knob or direction keys to modify this parameter.

For more details, please refer to "**Parameter Input**".

Table 2-23 Demod Time

Parameter	Explanation
Default	100 ms
Range	5 ms to 1000 s
Unit	ks, s, ms, us, ns, ps
Knob Step	0 to 100 ms, step = 1 ms 100 ms to 1 s, step = 10 ms 1 s to 10 s, step = 100 ms 10 s to 100 s, step = 1 s 100 s to 1000 s, step = 10 s
Direction Key Step	in 1, 2, 5 sequence

Source (DSA1030A-TG)

Source

When the Source is On, a signal with the same frequency of the current sweep signal will be output from the **GEN OUTPUT 50Ω** terminal on the front panel (You are recommended to use the tracking signal ranges from 10 MHz to 3 GHz). The Power of the signal could be set through the menu key. Two working modes are available in the source. They are Power Sweep output and Fixed Power output (when Power Sweep is Off).

The Source function is only valid for DSA1030A-TG.

TG level

Sets the output power of the signal from the tracking generator (TG). In Power Sweep mode, this parameter indicates the start power of the sweep. You can use the numeric keys, knob or direction keys to modify this parameter. For more details, please refer to "**Parameter Input**".

Table 2-24 TG level

Parameter	Explanation
Default	0 dBm
Range	-20 dBm to 0 dBm
Unit	dBm, -dBm, mV, uV
Knob Step	1 dBm
Direction Key Step	10 dBm

TG Level Offset

Sets the offset of the output power from the TG when gains or losses occur between the TG output and peripheral equipment, in order to display the actual power value.

Key Points:

- This parameter only changes the readout of the TG output power, rather than the actual value of it.
- The offset could be either a positive (gain) or a negative (loss).
- You can use the numeric keys, knob or direction keys to modify this parameter. For more details, please refer to **"Parameter Input"**.

Table 2-25 TG Level Offset

Parameter	Explanation
Default	0 dB
Range	-200 dB to 200 dB
Unit	dB
Knob Step	1 dB
Direction Key Step	10 dB

Power Sweep

Enables or disables the power sweep function. If enabled, the power from the TG varies with the sweep rate of the analyzer within the specified range (from start to stop frequency) and increases gradually starting from the specified TG power (see **"TG level"**) within specified power range (see **"Power Range"**). If disabled, the TG output is fixed at the specified power (see **"TG level"**).

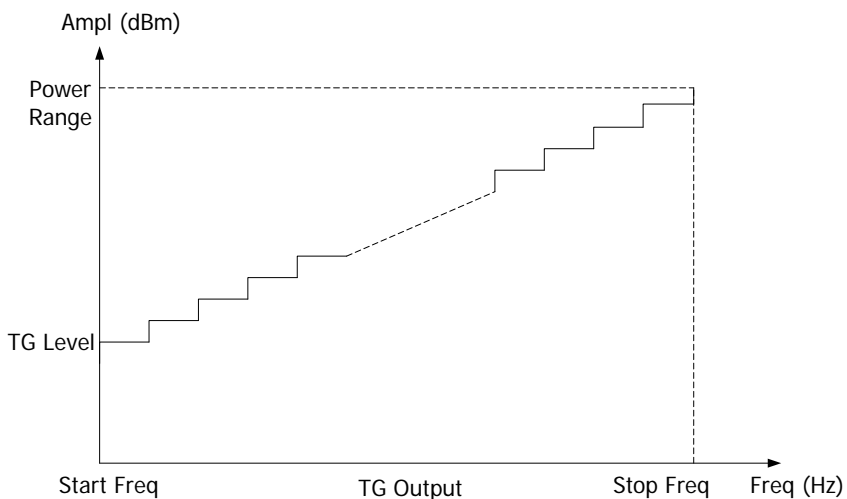

Figure 2-14 Power sweep

Power Range

Sets the power range that can be output from the TG while in power sweep mode, forming the boundary parameters under the Power Sweep mode together with the TG Level.

You can use the numeric keys, knob or direction keys to modify this parameter. For more details, please refer to “**Parameter Input**”.

Table 2-26 Power Range of TG

Parameter	Explanation
Default	0 dB
Range	0 dB to 20 dB
Unit	dB
Knob Step	1 dB
Direction Key Step	10 dB

Freq Offset

Sets the offset between the TG signal frequency and the current sweep frequency of the analyzer.

Key Points:

- If a frequency offset is generated from the TG signal passing from the receiver, you can set this parameter to eliminate it in order to match the displayed frequency to the TG frequency.
- You can use the numeric keys to modify this parameter, please refer to “**Parameter Input**” for more details.

Table 2-27 Frequency Offset

Parameter	Explanation
Default	0 Hz
Range	-300 MHz to 300 MHz
Unit	GHz, MHz, kHz, Hz
Knob Step	N/A
Direction Key Step	N/A

Normalize

Eliminates the error from TG Level. Before using this function, connect the **GEN OUTPUT 50Ω** output of TG with the **RF INPUT 50Ω** input of the analyzer.

1. Stor Ref

Saves the data of Trace 1 to Trace 3 as the reference value for normalization. This operation should be done before you enable the normalization.

2. Normalize

Enables or disables the normalization. When enabled, the reference trace will be stored automatically after the current sweep completes if no reference trace is stored before. During storing the reference trace, the interface displays corresponding message. The trace data subtracts the corresponding value of reference trace after every sweep.

3. Reference level

Adjusts the vertical position of trace on the screen when normalization is On.

- Being different from the **Reference level** function upon the **AMPT** menu, this parameter has no influence on the reference level of the analyzer.
- You can use the numeric keys, knob or direction keys to modify this parameter. For more details, please refer to "**Parameter Input**".

Table 2-28 Reference level under normalization

Parameter	Explanation
Default	0 dB
Range	-200 dB to 200 dB
Unit	dB
Knob Step	1 dB
Direction Key Step	10 dB

4. Norm Ref Pos

Adjusts this parameter to set the vertical position of the normalization reference level on the screen when normalization is On.

- The same as the function of Reference level above, when setting this parameter to 0%, the position of Reference level above will be at the

- bottom of screen grip, when setting to 100%, it will be at the top.
- You can use the numeric keys, knob or direction keys to modify this parameter. For more details, please refer to **“Parameter Input”**.

Table 2-29 TG reference position

Parameter	Explanation
Default	100%
Range	0 to 100%
Unit	%
Knob Step	1%
Direction Key Step	10%

5. Ref Trace

Sets whether to display the reference trace or not. If View is selected, the reference trace saved (Trace 3) will be shown in the trace type of Freeze.

Note: When normalization is enabled, the unit of Y-axis is “dB” and will not be influenced by the definition in **AMPT** → **Units** and “(dB)” is displayed under the Y-axis scale in the user interface (as shown in the figure below).

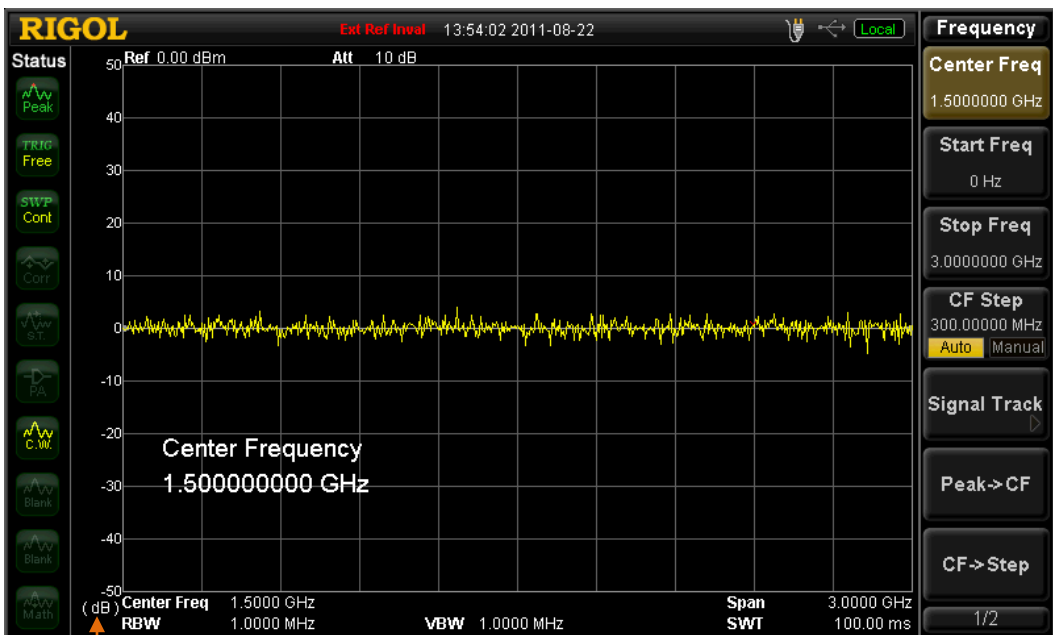

The unit of Y-axis is “dB” when normalization is enabled

Advanced Measurements

Meas

This key provides plenty of advanced measurement functions including T-Power, ACP (Adjacent Channel Power), Chan Pwr (Channel Power), OBW (Occupied Bandwidth), EBW (Emission Bandwidth), C/N Ratio, Harmo Dist (Harmonic Distortion), TOI (Third Order Intermodulation) and Pass/Fail. The measure mode can be Single or Continue and you can control the measurement through options including **Restart**, **Pause**, or **Resume** at will.

Meas Fctn

After you select a measurement function, the screen is divided into two windows, the upper window is the basic measurement displaying with a sweep trace, and the lower window holds the results. Through the **Screen Control** key you can switch between different windows and zoom the window.

1. T-Power

Enables the Zero Span mode and calculates the power within time domain. The measurable power types are Peak, Average, and RMS. Select the **T-Power** measurement and press **Meas Setup** to set corresponding parameters.

2. ACP

Measures the powers of the main channel and adjacent channels as well as the power difference between the main and each of the adjacent channels. When enabled, values of both the span and resolution bandwidth of the analyzer are adjusted to be smaller automatically. Select the **ACP** measurement and press **Meas Setup** to set corresponding parameters.

3. Channel Power

Measures the power and power density within a specified channel bandwidth. The span and resolution bandwidth in this measurement type are automatically set to smaller values. Select the **Channel Power** measurement and press **Meas Setup** to set

corresponding parameters.

4. **OBW**

Calculates the power within the whole bandwidth by integral operation and works out the occupied bandwidth by this value based on the specified power ratio. The center frequency difference between the measured channel and the analyzer will also be given in the measurement result.

Select the **OBW** measurement and press **Meas Setup** to set corresponding parameters.

5. **EBW**

Measures the bandwidth of the two points at both sides of the max signal when the amplitude of this max signal falls off X dB within the span range.

Select the **EBW** measurement and press **Meas Setup** to set corresponding parameters.

6. **C/N Ratio**

Measures the power of both the carrier and noise within specified bandwidth as well as their power ratio.

Select the **C/N Ratio** measurement and press **Meas Setup** to set corresponding parameters.

7. **Harmo Dist**

Measures each order harmonic power and THD of the carrier. The available range is up to 10 orders, and the fundamental wave amplitude must be higher than -50 dBm or else the measurement will be invalid.

Select the **Harmo Dist** measurement and press **Meas Setup** to set corresponding parameters.

8. **TOI**

Measures the parameters of the production generated by two signals which have the same amplitude and similar frequency. The measured results include the Frequency and Amplitude of the Base Lower, Base Upper, 3rd Order Lower and 3rd Order Upper signal, as well as the Intercepts of both the Base Lower and Base Upper.

Select the **TOI** measurement and press **Meas Setup** to set corresponding parameters.

9. Pass/Fail

Compares the measured curve with the pre-edited, if the related rules are met, the result will be "Pass", or else is "Fail".

Select the **Pass/Fail** measurement and press **Meas Setup** to set corresponding parameters.

Restart

Re-executes the active or suspended measurement.

Pause

Suspends the measurement after current measurement. However, the sweep is continuous when pressed, an icon  is shown on the results window, and the measurement data stops updating.

Resume

Restarts the suspended measurement. An icon  is shown at the result window, and the measurement data begins updating again.

Meas Mode

Sets the measurement mode to Single or Continue. In single mode, the analyzer stops after a specified number of measurements. After this, every time you press **Single**, measurements will be executed a specified number of times and measurement data will be updated. In Continue mode, the analyzer measures continuously.

Meas Setup

Sets the parameters for the specified measurement under **Meas** function. This operation is invalid if no measurement is enabled.

T-Power

Measurement Interface:

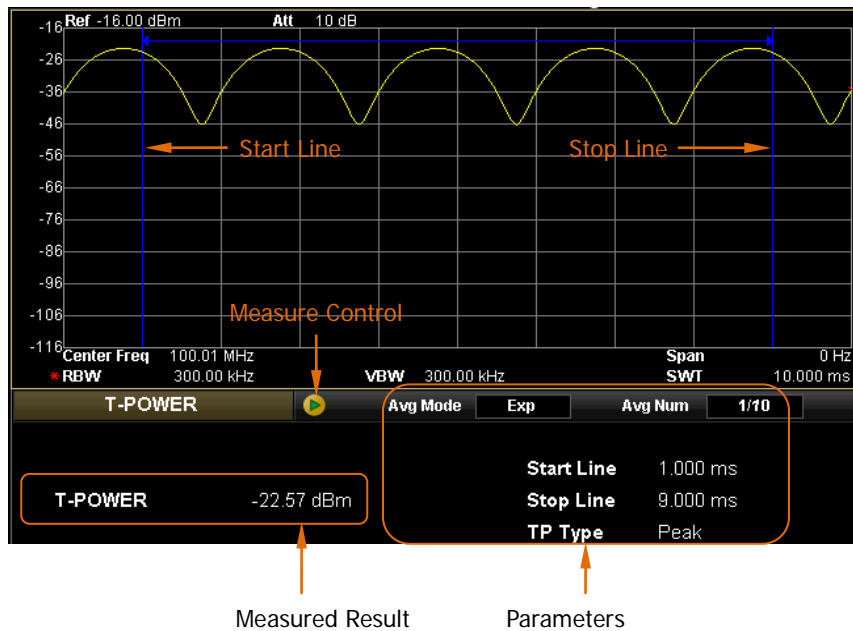

Figure 2-15 Interface of T-Power measurement

Result:

Magnitude of T-Power. That is the signal power value from the start to stop line.

Parameters:

In this mode, setting parameters are Avg Num, Avg Mode, TP Type, Start Line and Stop Line.

1. Avg Num

Sets the average number for the measurement, the default is Off.

You can use the numeric keys, knob or direction keys to modify this parameter.

For more details, please refer to "Parameter Input".

Table 2-30 Average number for T-Power measurement

Parameter	Explanation
Default	10
Range	1 to 1000
Unit	N/A
Knob Step	1
Direction Key Step	1

2. Avg Mode

Sets the Average operation to Exp or Repeat, the default is Exp.

- In Exp mode, the result is from the exponent average calculation of the current N (specified by **Avg Num**) measurements.
- In Repeat mode, the result is the arithmetic average of the current N (specified by **Avg Num**) measurements.

3. TP Type

● Peak

Displays the power value of the maximum signal between the start and stop lines. The detector in this type is changed to Pos Peak automatically.

● Average

Displays the average power of the signals between the start and stop lines. The detector in this type is changed to "Voltage Avg" automatically.

● RMS

Displays the power which is the root-mean-square value the signals between the start and stop lines. The detector in this type is changed to "RMS Avg" automatically.

4. Start Line

Sets the left margin when measuring the T-Power using the time units. The data calculated under this measurement is from the start to stop line.

You can use the numeric keys, knob or direction keys to modify this parameter.

For more details, please refer to "**Parameter Input**".

Table 2-31 The Start Line under T-Power measurement

Parameter	Explanation
Default	0 us
Range	0 ms to Stop line
Unit	ks, s, ms, us, ns, ps
Knob Step	Sweep time/600
Direction Key Step	in 1, 1.5, 2, 3, 5, 7.5 sequence

5. Stop Line

Sets the right margin when measuring the T-Power using the time units. The data calculated under this measurement is from the start to stop line.

You can use the numeric keys, knob or direction keys to modify this parameter.

For more details, please refer to "**Parameter Input**".

Table 2-32 The Stop Line under T-Power measurement

Parameter	Explanation
Default	100 ms
Range	Start line to Sweep time
Unit	ks, s, ms, us, ns, ps
Knob Step	Sweep time/600
Direction Key Step	in 1, 1.5, 2, 3, 5, 7.5 sequence

ACP

Measurement Interface:

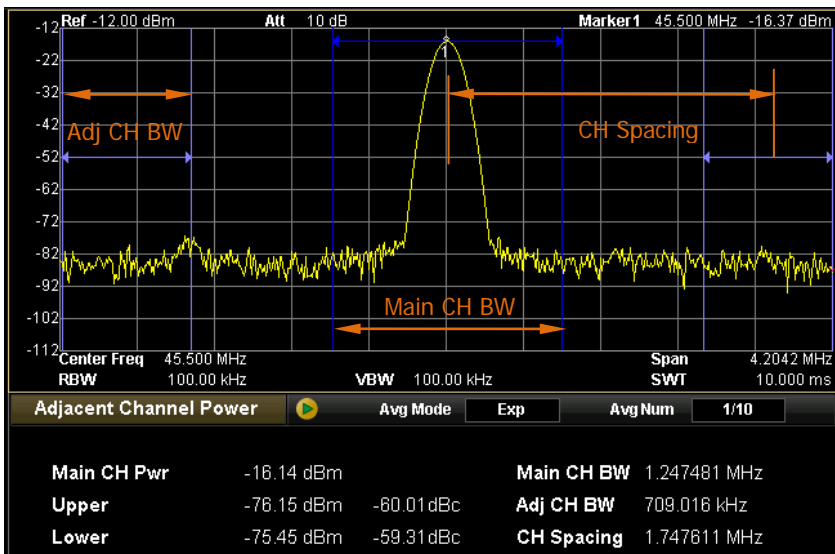

Figure 2-16 Interface of ACP measurement

Result:

The results under ACP measurement contain the Main CH Pwr, Upper and Lower.

- CH Pwr: displays the power value within the bandwidth of main channel.
- Upper: displays the power value of the next channel up in frequency and the difference with the main channel (Unit is dBc).
- Lower: displays the power value of the next channel down in frequency and the difference with the main channel (Unit is dBc).

Parameters:

In this mode, setting parameters are Avg Num, Avg Mode, Main CH BW, Adj CH BW, and CH Spacing.

1. Avg Num

Sets the average number for the measurement, the default is Off.

You can use the numeric keys, knob or direction keys to modify this parameter.

For more details, please refer to "Parameter Input".

Table 2-33 Average number for ACP measurement

Parameter	Explanation
Default	10
Range	1 to 1000
Unit	N/A
Knob Step	1
Direction Key Step	1

2. Avg Mode

Sets the Average operation to Exp or Repeat, the default is Exp.

- In Exp mode, the result is from the exponent average calculation of the current N (specified by **Avg Num**) measurements.
- In Repeat mode, the result is the arithmetic average of the current N (specified by **Avg Num**) measurements.

3. Main CH BW

Sets the bandwidth of the main channel. The power of the main channel is the power integral within this bandwidth.

You can use the numeric keys, knob or direction keys to modify this parameter.

For more details, please refer to "**Parameter Input**".

Table 2-34 The main channel bandwidth of ACP measurement

Parameter	Explanation
Default	2 MHz
Range	33 Hz to 1 GHz
Unit	GHz, MHz, kHz, Hz
Knob Step	Main CH BW/100, Min = 1Hz
Direction Key Step	in 1, 1.5, 2, 3, 5, 7.5 sequence

4. Adj CH BW

Sets the frequency bandwidth of the adjacent channels.

- The Adj CH BW is related to the Main CH BW, which can be set within Main CH BW/20 and Main CH BW×20.
- You can use the numeric keys, knob or direction keys to modify this parameter. For more details, please refer to "**Parameter Input**".

Table 2-35 The adjacent channel bandwidth of ACP measurement

Parameter	Explanation
Default	2 MHz
Range	33 Hz to 1 GHz
Unit	GHz, MHz, kHz, Hz
Knob Step	Adj CH BW/100, Min = 1 Hz
Direction Key Step	1, 1.5, 2, 3, 5, 7.5 sequence

5. CH Spacing

Sets the spacing between the main and adjacent channels.

- Changing this parameter may adjust the channel distance from the main to the upper and lower.
- You can use the numeric keys, knob or direction keys to modify this parameter. For more details, please refer to "**Parameter Input**".

Table 2-36 Spacing of the ACP measurement

Parameter	Explanation
Default	2 MHz
Range	33 Hz to 1 GHz
Unit	GHz, MHz, kHz, Hz
Knob Step	CH Spacing/100, Min = 1 Hz
Direction Key Step	in 1, 1.5, 2, 3, 5, 7.5 sequence

Chan Pwr

Measurement Interface:

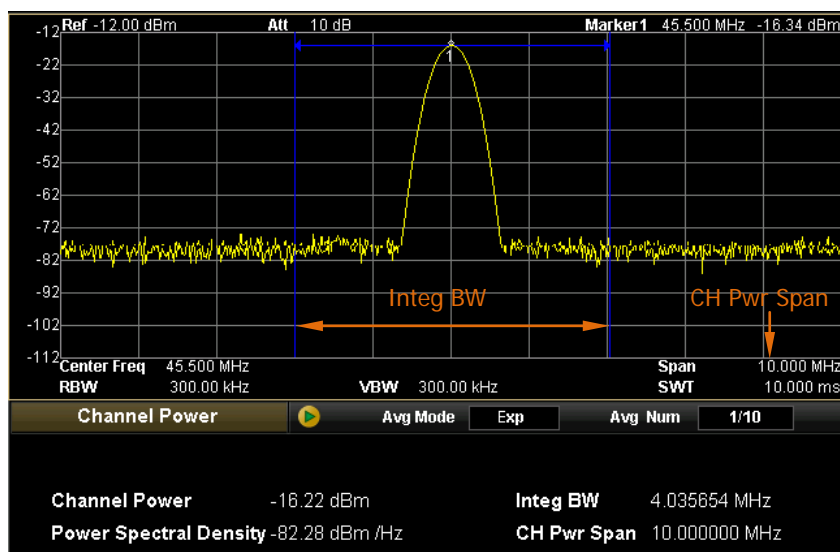

Figure 2-17 Interface of Chan Pwr measurement

Result:

The results under Chan Pwr measurement contain Channel Power and Power Spectral Density.

- Channel Power: the power within the integral bandwidth.
- Power Spectral Density: the power which is normalized to 1 Hz within the integral bandwidth (Unit is dBm/Hz).

Parameters:

In this mode, setting parameters are Avg Num, Avg Mode, Integ BW and Ch Pwr Span.

1. Avg Num

Sets the average number for the measurement, the default is Off.

You can use the numeric keys, knob or direction keys to modify this parameter.

For more details, please refer to **“Parameter Input”**.

Table 2-37 Average number for Chan Pwr measurement

Parameter	Explanation
Default	10
Range	1 to 1000
Unit	N/A
Knob Step	1
Direction Key Step	1

2. Avg Mode

Sets the Average operation to Exp or Repeat, the default is Exp.

- In Exp mode, the result is from the exponent average calculation of the current N (specified by **Avg Num**) measurements.
- In Repeat mode, the result is the arithmetic average of the current N (specified by **Avg Num**) measurements.

3. Integ BW

Sets the bandwidth of the channel under measure. The power of the channel is the power integral within this bandwidth.

You can use the numeric keys, knob or direction keys to modify this parameter.

For more details, please refer to "**Parameter Input**".

Table 2-38 Integral bandwidth of Chan Pwr measurement

Parameter	Explanation
Default	2 MHz
Range	100 Hz to 3 GHz
Unit	GHz, MHz, kHz, Hz
Knob Step	Integ BW/100, Min = 1 Hz
Direction Key Step	in 1, 1.5, 2, 3, 5, 7.5 sequence

4. Ch Pwr Span

Sets the channel frequency range, whose value is the same as the span of the analyzer, indicating the frequency range of sweep. Changing this parameter would alter the span of the analyzer.

- This value is related to the Integ BW, which can be set within the Integ BW and 20 times of it.
- You can use the numeric keys, knob or direction keys to modify this parameter. For more details, please refer to "**Parameter Input**".

Table 2-39 The Channel span of Chan Pwr measurement

Parameter	Explanation
Default	3 MHz
Range	100 Hz to 3 GHz
Unit	GHz, MHz, kHz, Hz
Knob Step	CH Pwr Span/100, Min = 1 Hz
Direction Key Step	in 1, 1.5, 2, 3, 5, 7.5 sequence

OBW

Measurement Interface:

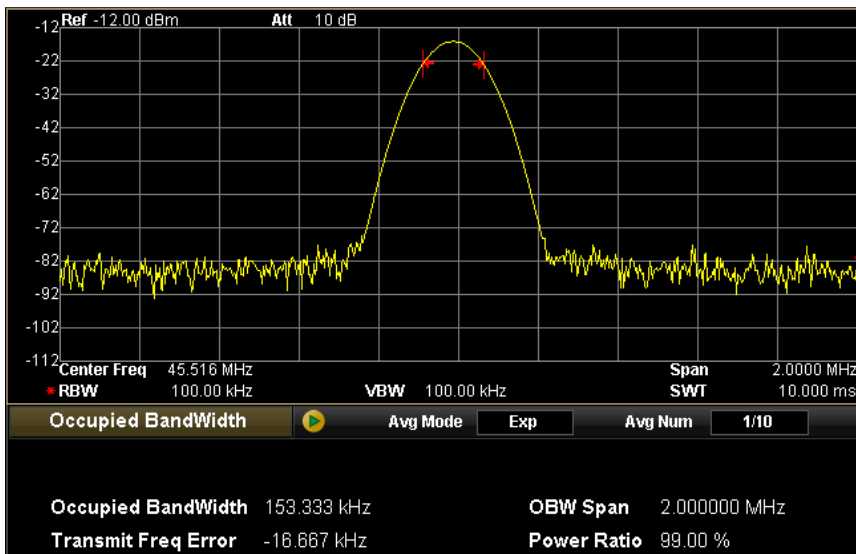

Figure 2-18 Interface of OBW measurement

Result:

The results under OBW measurement contain Occupied Bandwidth and Transmit Freq Error.

- Occupied Bandwidth: make integral calculation of the power within the whole span and then work out the occupied bandwidth of it according to the specified power ratio.
- Transmit Freq Error: the center frequency difference between the measured channel and the analyzer.

Parameters:

In this mode, setting parameters are Avg Num, Avg Mode, Max Hold, Span and Power Ratio.

1. Avg Num

Sets the average number for the measurement, the default is Off. You can use the numeric keys, knob or direction keys to modify this parameter. For more details, please refer to "Parameter Input".

Table 2-40 Average number for OBW measurement

Parameter	Explanation
Default	10
Range	1 to 1000
Unit	N/A
Knob Step	1
Direction Key Step	1

2. Avg Mode

Sets the Average operation to Exp or Repeat, the default is Exp.

- In Exp mode, the result is from the exponent average calculation of the current N (specified by **Avg Num**) measurements.
- In Repeat mode, the result is the arithmetic average of the current N (specified by **Avg Num**) measurements.

3. Max Hold

Enables or disables the Max Hold function, the default is Off.

- Hold On: always displays the maximum measurement result.
- Hold Off: displays the current measurement result.
- This function and Avg Mode are mutually exclusive options, if you enable the Max Hold, the Avg Mode will be disabled automatically.

4. Span

Sets the frequency range of the integral operation. This value is equal to the span of the analyzer, indicating the frequency range of sweep. Changing this parameter may cause the span of the analyzer to change.

You can use the numeric keys, knob or direction keys to modify this parameter.

For more details, please refer to "**Parameter Input**".

Table 2-41 The Span of OBW measurement

Parameter	Explanation
Default	2 MHz
Range	100 Hz to 3 GHz
Unit	GHz, MHz, kHz, Hz
Knob Step	Occupied BW Span /100, Min = 1Hz
Direction Key Step	in 1, 1.5, 2, 3, 5, 7.5 sequence

5. Power Ratio

Sets the power percentage of the signal that is within the integrating span.

You can use the numeric keys, knob or direction keys to modify this parameter.

For more details, please refer to "**Parameter Input**".

Table 2-42 The Power Ratio of OBW measurement

Parameter	Explanation
Default	99%
Range	1% to 99.99%
Unit	%
Knob Step	0.01%
Direction Key Step	1%

EBW

Measurement Interface:

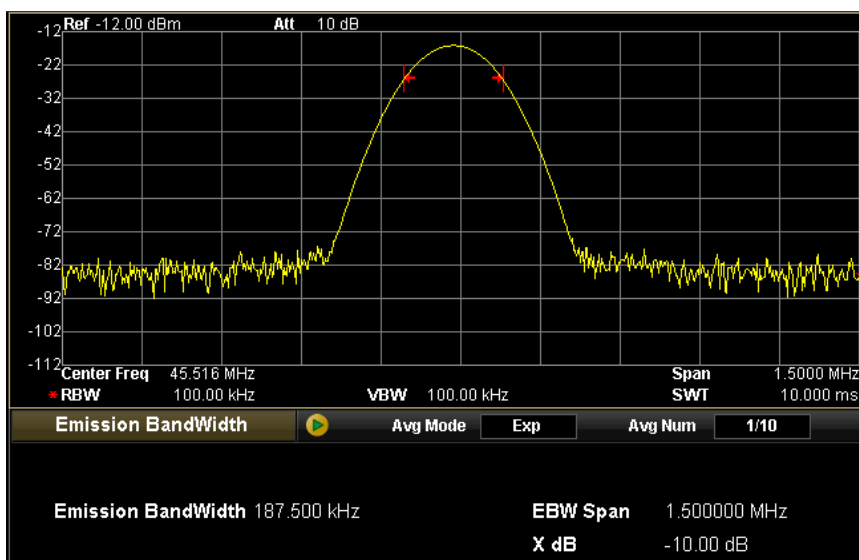

Figure 2-19 Interface of EBW measurement

Result:

EBW is the bandwidth between the two points at both sides of the max signal where the amplitude falls off X dB within the span range. When the measurement starts, the analyzer first confirms the frequency f_0 of the max amplitude point within the span range and then starts searching for the points (f_1 and f_2) on both sides with X dB drop in amplitude. The EBW is equal to $f_2 - f_1$.

Parameters:

In this mode, setting parameters are Avg Num, Avg Mode, Max Hold, Span and EBW X dB.

1. Avg Num

Sets the average number for the measurement, the default is Off.

You can use the numeric keys, knob or direction keys to modify this parameter.

For more details, please refer to "Parameter Input".

Table 2-43 Average number for EBW measurement

Parameter	Explanation
Default	10
Range	1 to 1000
Unit	N/A
Knob Step	1
Direction Key Step	1

2. Avg Mode

Sets the Average operation to Exp or Repeat, the default is Exp.

- In Exp mode, the result is from the exponent average calculation of the current N (specified by **Avg Num**) measurements.
- In Repeat mode, the result is the arithmetic average of the current N (specified by **Avg Num**) measurements.

3. Max Hold

Enables or disables the Max Hold function, the default is Off.

- Hold On: always displays the maximum measurement result.
- Hold Off: displays the current measurement result.
- This function and Avg Mode are mutually exclusive options, if you enable the Max Hold, the Avg Mode will be disabled automatically.

4. Span

This value is equal to the span of the analyzer, indicating the frequency range of the sweep. Changing this parameter will cause a change in the span of the analyzer.

You can use the numeric keys, knob or direction keys to modify this parameter.

For more details, please refer to "**Parameter Input**".

Table 2-44 The Span of EBW measurement

Parameter	Explanation
Default	2 MHz
Range	100 Hz to 3 GHz
Unit	GHz, MHz, kHz, Hz
Knob Step	Emission BW Span/100, Min = 1 Hz
Direction Key Step	in 1, 1.5, 2, 3, 5, 7.5 sequence

5. X dB

Sets the value of X dB to calculate the emission bandwidth.

You can use the numeric keys, knob or direction keys to modify this parameter.

For more details, please refer to "**Parameter Input**".

Table 2-45 X dB

Parameter	Explanation
Default	-10 dB
Range	-100 dB to -0.1 dB
Unit	dB
Knob Step	0.1 dB
Direction Key Step	1 dB

C/N Ratio

Measurement Interface:

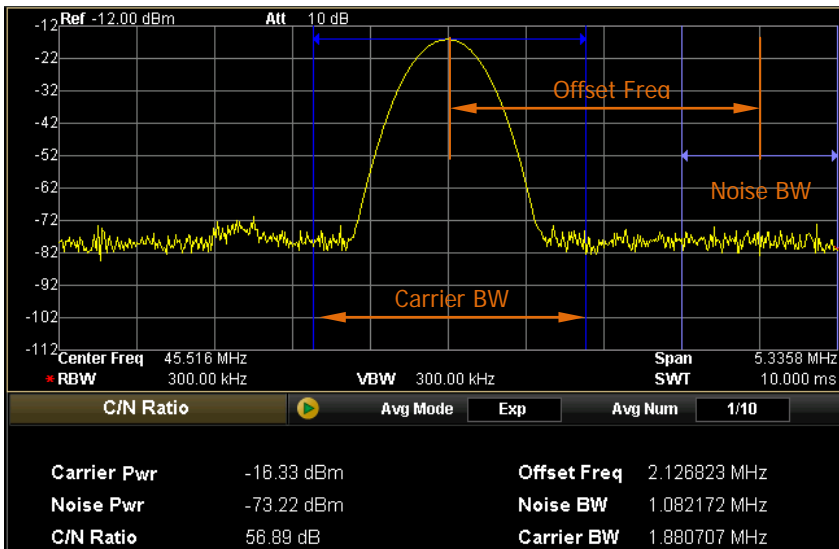

Figure 2-20 Interface of C/N Ratio measurement

Result:

The results under this mode contain the Carrier Pwr, Noise Pwr, and C/N Ratio.

- Carrier Pwr: the power within carrier bandwidth
- Noise Pwr: the power within noise bandwidth
- C/N Ratio: the ratio of the carrier power to the noise power

Parameters:

In this mode, setting parameters are Avg Num, Avg Mode, Offset Freq, Noise BW and Carrier bandwidth.

1. Avg Num

Sets the average number for the measurement, the default is Off.

You can use the numeric keys, knob or direction keys to modify this parameter.

For more details, please refer to "Parameter Input".

Table 2-46 Average number for C/N Ratio measurement

Parameter	Explanation
Default	10
Range	1 to 1000
Unit	N/A
Knob Step	1
Direction Key Step	1

2. Avg Mode

Sets the Average operation to Exp or Repeat, the default is Exp.

- In Exp mode, the result is from the exponent average calculation of the current N (specified by **Avg Num**) measurements.
- In Repeat mode, the result is the arithmetic average of the current N (specified by **Avg Num**) measurements.

3. Offset Freq

Sets the center frequency difference between the carrier and the noise.

You can use the numeric keys, knob or direction keys to modify this parameter.

For more details, please refer to "**Parameter Input**".

Table 2-47 The Offset Freq of C/N Ratio measurement

Parameter	Explanation
Default	2 MHz
Range	33 Hz to 1 GHz
Unit	GHz, MHz, kHz, Hz
Knob Step	Offset Freq/100, Min = 1 Hz
Direction Key Step	in 1, 1.5, 2, 3, 5, 7.5 sequence

4. Noise BW

Sets the bandwidth of the noise for measurement.

You can use the numeric keys, knob or direction keys to modify this parameter.

For more details, please refer to "**Parameter Input**".

Table 2-48 Noise BW of C/N Ratio measurement

Parameter	Explanation
Default	2 MHz
Range	33 Hz to 1 GHz
Unit	GHz, MHz, kHz, Hz
Knob Step	Noise BW/100, Min = 1 Hz
Direction Key Step	in 1, 1.5, 2, 3, 5, 7.5 sequence

5. Carrier BW

Sets the bandwidth of the carrier for measurement.

- This value is related to the Noise BW, which can be set within Noise BW/20 and 20*Noise BW.
- You can use the numeric keys, knob or direction keys to modify this parameter. For more details, please refer to "**Parameter Input**".

Table 2-49 The Carrier BW of C/N Ratio measurement

Parameter	Explanation
Default	2 MHz
Range	33 Hz to 1 GHz
Unit	GHz, MHz, kHz, Hz
Knob Step	Carrier BW/100, Min = 1 Hz
Direction Key Step	in 1, 1.5, 2, 3, 5, 7.5 sequence

Harmo Dist

Measurement Interface:

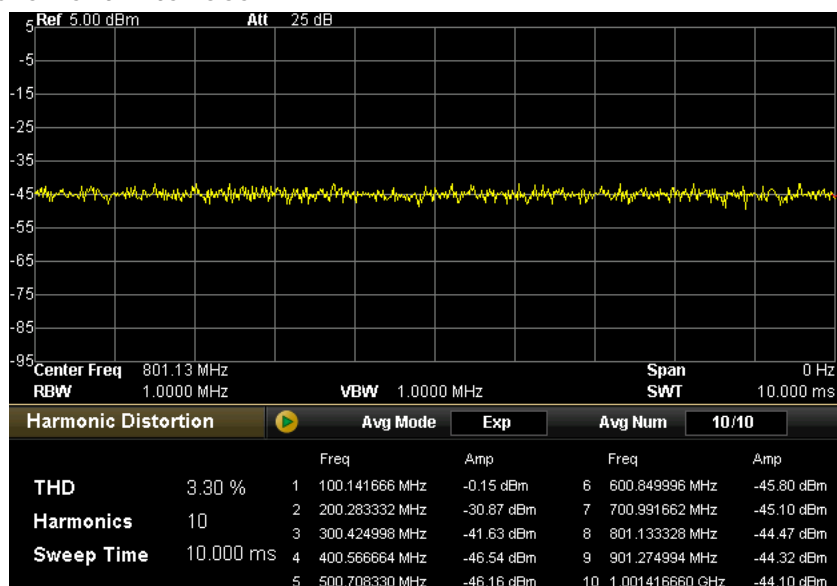

Figure 2-21 Interface of Harmo Dist measurement

Result:

The results under this mode contain the amplitude of each harmonic and THD. Up to 10 times harmonics can be measured.

Parameters:

In this mode, setting parameters are Avg Num, Avg Mode, NO.of Harmo and Harmonic ST (Sweep Time).

1. Avg Num

Sets the average number for the measurement, the default is Off.

You can use the numeric keys, knob or direction keys to modify this parameter.

For more details, please refer to **"Parameter Input"**.

Table 2-50 Average number for Harmo Dist measurement

Parameter	Explanation
Default	10
Range	1 to 1000
Unit	N/A
Knob Step	1
Direction Key Step	1

2. Avg Mode

Sets the Average operation to Exp or Repeat, the default is Exp.

- In Exp mode, the result is from the exponent average calculation of the current N (specified by **Avg Num**) measurements.
- In Repeat mode, the result is the arithmetic average of the current N (specified by **Avg Num**) measurements.

3. NO.of Harmo

Sets the number of harmonics to be measured, which is used for calculating the total harmonics.

You can use the numeric keys, knob or direction keys to modify this parameter.

For more details, please refer to "**Parameter Input**".

Table 2-51 Number of harmonics for Harmo Dist measurement

Parameter	Explanation
Default	10
Range	2 to 10
Unit	N/A
Knob Step	1
Direction Key Step	1

4. Harmonic ST

Sets the sweep time during the harmonic measurement, which is the sweep time of the analyzer.

You can use the numeric keys, knob or direction keys to modify this parameter.

For more details, please refer to "**Parameter Input**".

Table 2-52 The Sweep Time of Harmo Dist measurement

Parameter	Explanation
Default	10 ms
Range	20 us to 3 ks
Unit	ks, s, ms, us, ns, ps
Knob Step	Sweep Time/100, minimum 1 ms
Direction Key Step	In 1, 1.5, 2, 3, 5, 7.5 sequence

TOI

Measurement Interface:

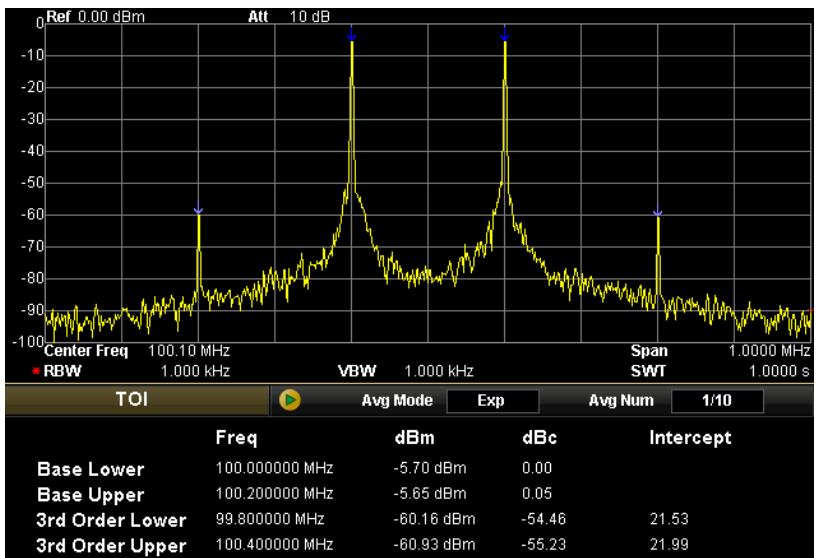

Figure 2-22 Interface of TOI measurement

Result:

The results under this mode contain the frequency and amplitude of the Base Lower, Base Upper, 3rd Order Lower and 3rd Order Upper signals, the amplitude difference of each signal with the Base Lower, as well as the Intercepts of both the Base Lower and Base Upper.

Parameters:

In this mode, setting parameters are Avg Num, Avg Mode and Span.

1. Avg Num

Sets the average number for the measurement, the default is Off. You can use the numeric keys, knob or direction keys to modify this parameter. For more details, please refer to "Parameter Input".

Table 2-53 Average number for TOI measurement

Parameter	Explanation
Default	10
Range	1 to 1000
Unit	N/A
Knob Step	1
Direction Key Step	1

2. Avg Mode

Sets the Average operation to Exp or Repeat, the default is Exp.

- In Exp mode, the result is from the exponent average calculation of the current N (specified by **Avg Num**) measurements.
- In Repeat mode, the result is the arithmetic average of the current N (specified by **Avg Num**) measurements.

3. Span

This value equals the span of the analyzer, indicating the frequency range of sweep. Changing this parameter changes the span of the analyzer.

You can use the numeric keys, knob or direction keys to modify this parameter.

For more details, please refer to "**Parameter Input**".

Table 2-54 The Span of TOI measurement

Parameter	Explanation
Default	2 MHz
Range	100 Hz to 3 GHz
Unit	GHz, MHz, kHz, Hz
Knob Step	TOI Span/100, Min = 1 Hz
Direction Key Step	in 1, 1.5, 2, 3, 5, 7.5 sequence

Pass/Fail

Measurement Interface:

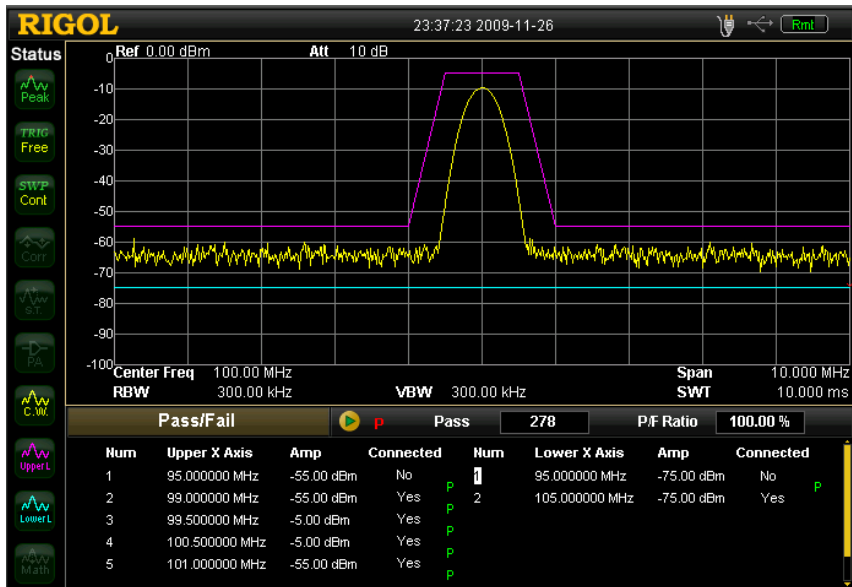

Figure 2-23 Interface of Pass/Fail measurement

Result:

The results under this mode contain the pass number and the Pass Ratio.

1. Limit

Selects the desired limit lines including Upper and Lower, and then sets the condition according to the **Edit** menu.

Note: T2 and T3 here are used for marking the Upper and Lower limits separately.

2. Test

Enables or disables the test function. Each limit has its own switch, you can test both together, either one, or neither.

Note: The **Pass/Fail** menu under the **Meas** key is only used to control the status of the measurement, not the status of Test.

3. Edit

Edits the properties of the limits.

Table 2-55 Pass/Fail menu

Parameter	Explanation
Limit	Quickly selects the limit line to be edited.
Point	Sets the number of the point to be edited. The range is from 1 to 200.
X-axis	Enters the frequency or time of the point you are editing.
Amplitude	Enters the amplitude of the point you are editing within -400 dBm and 330 dBm.
Connected	Connects this point with the previous one or not.
Del Point	Deletes the point you are editing.

4. X Axis

Sets the X-axis unit to Frequency or Time unit.

Note: The switch of units may delete all the edited points upon the current limit line.

5. Freq Interp

Sets the Freq Interp to Log or Lin. In Log mode, both the frequency and amplitude use Log to do interpolation operation; in Lin mode, the frequency uses a Lin unit and the amplitude uses a Log unit for interpolation operation.

6. Del Limit

Deletes the limit line you are editing.

7. Fail Stop

Selects whether to continue the next sweep if the test fails.

Marker Measurements

Marker

The marker appears as a rhombic sign (shown below) for identifying the point on the trace. We can easily readout the parameters of the marked point on the trace, such as the amplitude, frequency and sweep time.

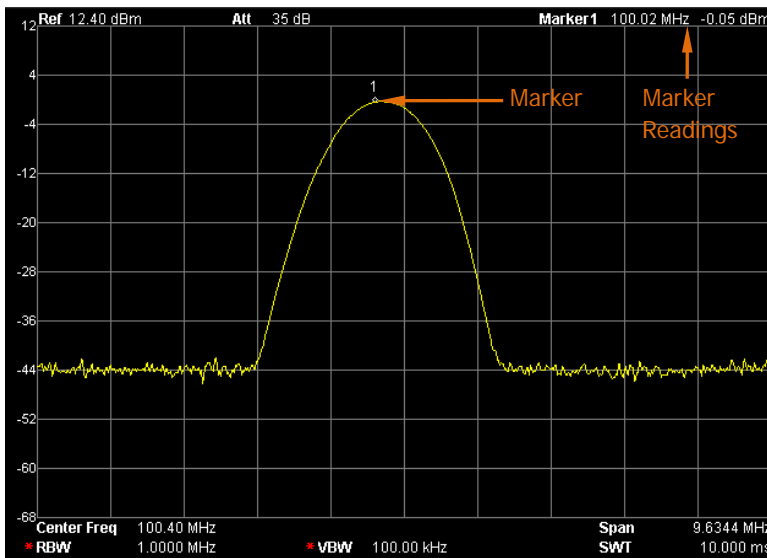

Figure 2-24 Schematic of the marker

Key Points:

- The analyzer allows for up to four groups of markers to be displayed at one time, but only one pair or one single marker is active every time.
- You can use the numeric keys, knob or direction keys to enter the desired frequency or time when any marker type menu is active, so as to view the readouts of different points on the trace.

Select Mkr

Selects one marker from the four, the default is Marker1. When a selection is made, you can set its type, trace to be marked, readout type and other related parameters. The enabled marker will appear on the selected trace through the **Mkr Trace** option, and the readouts of this marker are also displayed on the active area and the upper right of screen.

Table 2-56 Marker parameters

Parameter	Explanation
Default	Center Frequency
Range	0 to 3 GHz
Unit	Readout = Frequency (or Period), Unit is GHz, MHz, kHz, Hz (or ks, s, ms, us, ns, ps); Readout = Time (or 1/ Δ time), Unit is ks, s, ms, us, ns, ps (or GHz, MHz, kHz, Hz)
Knob Step*	Readout = Frequency (or Period), step = Span/[Min (Sweep Points, Number of Pixels in the Grid Area**) -1]; Readout = Time (or 1/ Δ time), step = Sweep Time/[Min (Sweep Points, Number of Pixels in the Grid Area**) -1]
Direction Key Step	Readout = Frequency (or Period), step = Span/10; Readout = Time (or 1/ Δ time), step = Sweep Time/10

Note:

*The step of the knob must be an integer multiple of the difference between the two neighboring sweep points. If the step calculated using the formula in the table above does not meet the requirement, the spectrum analyzer will select a value that meets the requirement and is nearest to the value calculated as the step automatically. For example, in frequency readout mode, the span is 3 GHz, the sweep points is 2001 and the number of pixels in the grid area is 601, the step = 3 GHz/(601-1) = 5 MHz. At this point, the frequency difference between two neighboring sweep points is 3 GHz/(2001-1) = 1.5 MHz; therefore, the actual step is 4.5 MHz (an integer multiple of 1.5 MHz and is nearest to 5 MHz).

**In non-full-screen display mode, the number of pixels in the grid area is 601; in full-screen mode, the number of pixels in the grid area is 751.

Normal

One of the marker types, which is used to measure the values of X (Frequency or Time) or Y (Amplitude) at certain point of the trace. When selected, a marker will appear with its own digital ID such as "1" on the trace.

Key Points:

- If no active marker exists currently, a one will be enabled automatically at the center frequency of current trace.
- You can use the knob, direction keys or numeric keys to move the marker. The readouts of the marker will be displayed on the upper right of the screen.
- The readout resolution of the X-axis corresponds to the span and sweep points. For higher resolution, add sweep points or reduce the span.

Delta

One of the marker types, which is used to measure the delta values of X (Frequency or Time) and Y (Amplitude) between the Reference point and certain point on the trace. When selected, a pair of markers appears on the trace, which are the Reference Marker (marked as a combination of the marker number and letter "R", such as "1R") and the Delta Marker (marked as the marker number, such as "1").

Key Points:

- The Reference Marker will be activated at the position of current marker, or else both the reference marker and Delta Marker will be simultaneously activated at the center frequency location if no marker is active at the present.
- The location of the Reference Marker is always fixed (both in the X-axis and the Y-axis), while the Delta Marker is active. You can use the numeric keys, knob or direction keys to change the location of Delta Marker.
- The delta of both the frequency (or Time) and the amplitude between the two markers are displayed at the upper right of the screen.
- One way to enable a certain point as the reference is to open a "Normal" marker and locate it onto a point and then switch the marker type into "Delta", creating a new reference, then you can modify the location of the delta point to achieve the delta measurement; the other way is to open a Delta Marker

and place it onto a point, then reselect the **Delta** menu to locate the marker you opened onto this point.

- If you activate the **Noise Mkr** function under the **Marker Fctn** key, the result of the noise measurement will be corrected automatically and normalized to 1 Hz.

The application of Delta marker

Measuring the signal-noise ratio of single spectrum signal, for example, separately place the Reference and Delta Markers onto the signal and noise, the amplitude shown in the measurement result is the signal-noise ratio.

Delta Pair

One of the marker types. When selected, a pair of markers will appear on the trace, which are the Reference Marker (marked as a combination of the marker number and letter "R", such as "1R") and the Delta Marker (marked as the marker number, such as "1").

Key Points:

- You can use the knob, direction keys or numeric keys to set the location of the Reference Marker (selecting Ref) and the Delta Marker (selecting Delta).
- This is different from the **Delta** type marker in that you can modify both the Reference and Delta Marker. Additionally, both the X and Y values of the Reference Marker are stable in "Delta" type during the sweep, but the Y value of the Reference Marker is updating along with the sweep in "Delta Pair" type.

Span Pair

One of the marker types. When selected, a pair of markers will appear on the trace, which are the Reference Marker (marked as a combination of the marker number and letter "R", such as "1R") and the Delta Marker (marked as the marker number, such as "1").

Key Points:

- You can use the knob, direction keys or numeric keys to set the location of both the Reference Marker and Delta Marker at the same time.

- If Span is selected, setting the Span Pair will keep the center position of the two markers and move them towards the two sides (value increasing) or the middle (value decreasing).
- If Center is selected, setting the Span Pair will keep the relative distance of the two markers and move their center position towards the left (value decreasing) or right (value increasing).
- This is different from the "Delta" type marker, in that you can modify both the Reference Marker and Delta Marker at the same time.

Off

Turns off the current selected marker. The marker information displayed on the screen and functions based on the marker will also be turned off.

Mkr Trace

Selects a trace to be used on the current marker from 1, 2, 3, Math or Auto (default). When Auto is selected, the system searches the desired trace in the order of Clear Write, Max Hold, Min Hold, Video Avg, Power Avg, Freeze, and then selects one of them in sequence of the trace number 1, 2 and 3 if more than two traces are found.

Readout

Selects a desired readout type of X-axis for the marker from Frequency, Period, Δ Time and $1/\Delta$ Time. Note this setting will cause a change in the type of readout but not in actual value. The type you select would also affect the marker readout shown on the active area and the upper right of screen.

1. Frequency

In this type, **Normal** marker shows the absolute frequency and the other types show the frequency difference between the Delta Marker and Reference Marker.

The default readout in non-zero span mode is Frequency.

2. Period

In this type, **Normal** marker shows the reciprocal value of frequency and the other types show the reciprocal value of frequency difference. When the frequency difference is zero, the displayed value is infinite (with 10 Ts displaying). Note this type is invalid in Zero span mode.

3. Δ Time

In this type, **Normal** marker shows the time difference between where the marker is located and the start of the sweep, while the other types show the sweep time difference between the Delta Marker and Reference Marker. The default readout in Zero span mode is Δ Time.

4. $1/\Delta$ Time

In this type, the reciprocal value of sweep time difference between the Delta Marker and Reference Marker will be shown. When the time difference is zero, the displayed value is infinite (with 100THz displaying). Note this type is available only in Zero span mode when a **Delta** type marker is selected and suitable for the frequency measurement of a video signal.

Marker Table

Displays all the opened markers on the lower portion of the screen, including Marker number (D represents normal marker or Delta marker, R represents Reference marker), Trace number, Marker readout type, X-axis, and Amplitude readout. Through this table you can view the measured value from multiple points. The table allows for up to eight markers to be displayed at one time. Pressing  to select the readout window and turning the knob to view the readouts of all the markers.

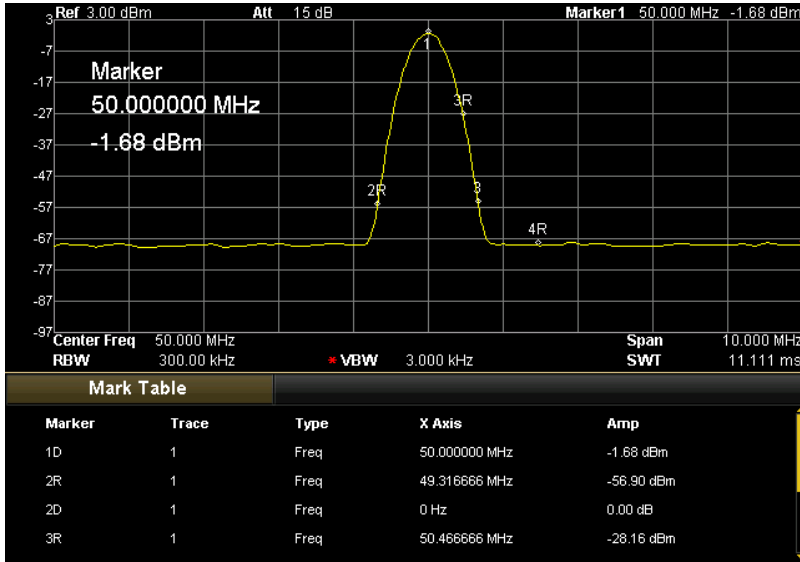

Figure 2-25 The marker schematic

All Off

Turns off all the opened markers and the related functions.

Marker->

Sets the other system parameters (such as Center frequency, Reference level) using the current marker readings. Press **Marker ->** to enable a marker if none of them are active at present.

Mkr->CF

Sets the center frequency of the analyzer based on the frequency of the current marker.

- If **Normal** is selected, the center frequency will be set to the frequency of the current marker.
- If **Delta**, **Delta Pair**, or **Span Pair** is selected, the center frequency will be set to the frequency at which the Delta Marker is located.
- The function is invalid in Zero span mode.

Mkr->Step

Sets the center frequency step of the analyzer based on the frequency of the current marker.

- If **Normal** is selected, the center frequency step will be set to the frequency of current marker.
- If **Delta**, **Delta Pair** or **Span Pair** is selected, the center frequency step will be set to the frequency at which the Delta Marker is located.
- The function is invalid in Zero span mode.

Mkr->Start

Sets the start frequency of the analyzer based on the frequency of the current marker.

- If **Normal** is selected, the start frequency will be set to the frequency of the current marker.
- If **Delta**, **Delta Pair** or **Span Pair** is selected, the start frequency will be set to the frequency at which the Delta Marker is located.
- The function is invalid in Zero span mode.

Mkr->Stop

Sets the stop frequency of the analyzer based on the frequency of the current marker.

- If **Normal** is selected, the stop frequency will be set to the frequency of the current marker.
- If **Delta**, **Delta Pair** or **Span Pair** is selected, the stop frequency will be set to the frequency at which the Delta Marker is located.
- The function is invalid in Zero span mode.

Mkr->Ref

Sets the reference level of the analyzer based on the amplitude of the current marker.

- If **Normal** is selected, the reference level will be set to the amplitude of the current marker.
- If **Delta**, **Delta Pair**, or **Span Pair** is selected, the reference level will be set to the amplitude at which the Delta Marker is located.

Mkr Δ ->CF

Sets the center frequency of the analyzer to the frequency difference between the two markers in the marker type of **Delta**, **Delta Pair**, or **Span Pair**.

The function is invalid in Zero span mode.

Mkr Δ ->Span

Sets the span of the analyzer to the frequency difference between the two markers in the marker type of **Delta**, **Delta Pair** or **Span Pair**.

The function is invalid in Zero span mode.

Marker Fctn

Executes specific marker functions such as Noise Mkr, N dB BW and Freq Count.

Select Mkr

Selects the marker to be used for the specified functions, the default is Marker 1.

Noise Mkr

Executes the Noise marker function for the selected marker and reads the **Power Spectral Density**.

Key Points:

- If the current marker selected here is Off in **Marker** menu, Pressing **Noise Mkr** will first enable the marker as a Normal type marker automatically, then start measuring the average noise level at the marked point and then normalize this value to 1 Hz bandwidth. During this process, certain compensation is always taken on the basis of different detection and trace types. The measurement will be more precise if using the detection type of RMS Avg or Sample.
- This function can be used for measuring the Noise ratio.

N dB BW

Enables the N dB BW measurement or sets the value of N. The N dB BW denotes the frequency difference between points that are located on both sides of the current marker while the amplitude falls off ($N < 0$) or rises ($N > 0$) N dB separately, see figure below:

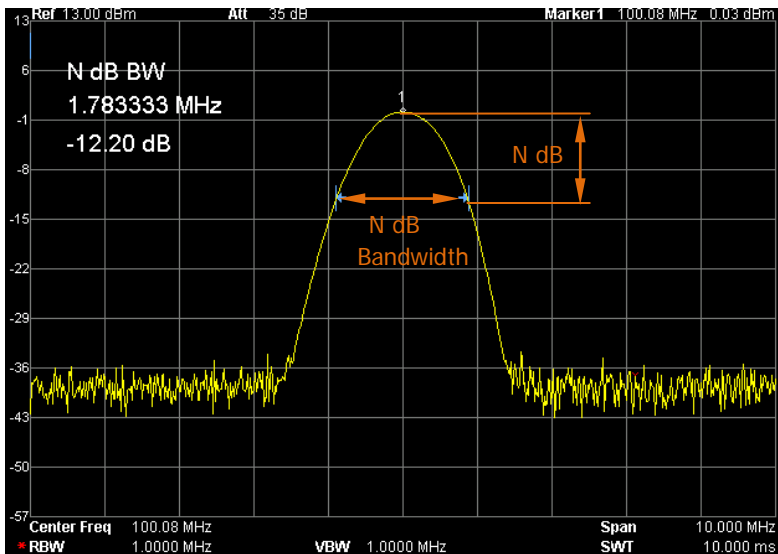

Figure 2-26 N dB BW measurement

Key Points:

- When the measurement starts, the analyzer will search the two points which are located at both sides of the current point and are N dB amplitudes smaller or greater than the current point, and display the frequency difference between the two points, or else display "---", indicating the search failed.
- You can use the numeric keys, knob or direction keys to modify the value of N, for more details please refer to “**Parameter Input**”.

Table 2-57 N dB BW parameter settings

Parameter	Explanation
Default	-3 dB
Range	-100 dB to 100 dB
Unit	dB
Knob Step	0.1 dB
Direction Key Step	1 dB

Function Off

Turns off the opened noise markers or N dB BW measurements, but not the markers themselves.

Freq Count

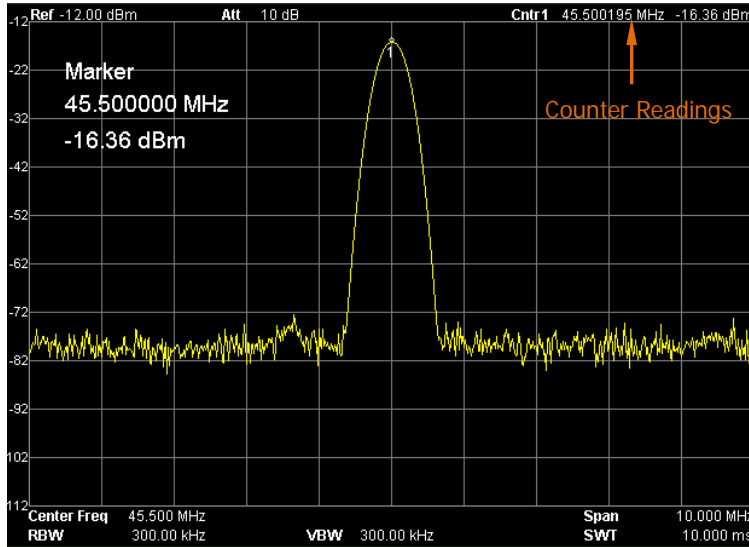

Figure 2-27 Frequency Count measurement

1. State

Turns on or off the frequency counter.

Key Points:

- If no active marker currently exists, turning on the counter will open a **Normal** marker automatically.
- The frequency readout is more accurate when the counter is **On**.
- The counter measures the frequency near the Center frequency in Zero span mode.

2. Resolution

Sets the resolution of frequency counter manually or automatically. The available resolutions are 1 Hz, 10 Hz, 100 Hz, 1 kHz, 10 kHz and 100 kHz.

Table 2-58 The resolution of frequency counter

Parameter	Explanation
Default	1 kHz
Range	1 Hz to 100 kHz
Unit	GHz, MHz, kHz, Hz
Knob Step	10 times
Direction Key Step	10 times

Peak

Executes peak searching immediately and opens the Peak setting menu.

Key Points:

- If **Max** is selected from the **Peak Search** option, it will search and mark the maximum on the trace.
- If **Param** is selected from the **Peak Search** option, it will search and mark the peak that meets the condition of the parameter.
- The peak search of Next Peak, Peak Right, Peak Left or peaks in the peak table must meet the specified parameter condition.
- The spurious signal at the zero frequency caused by LO feed through is ignored.
- When no peak that meets the specified parameter condition is found, the system will then prompt you with the message "**No peak found**".

Next Peak

Searches the peak whose amplitude is the closest to the current peak's and meets the searching condition in **Search Para**. The peak is then identified with a marker.

Peak Right

Searches the nearest peak located to the right side of the current peak and meets the searching condition. The peak is then identified with a marker.

Peak Left

Searches the nearest peak located to the left side of the current peak and meets the searching condition. The peak is then identified with a marker.

Min Search

Searches the peak with the minimum amplitude on the trace and identifies it with a marker.

Peak Peak

Executes the peak search and minimum search and identifies the results by a pair of markers. Note that the result under peak search is identified with a Delta Marker and the other is identified with a Reference Marker.

Cont Peak

Enables or disables the Cont peak search. The default is Off. When enabled, the system will always execute a peak search automatically after each sweep in order to track the signal under measurement.

The difference between Cont peak and Signal Track

In Cont peak, the system always searches for the maximum in the current channel; while in Signal Track, the system will search for and mark the point (with no more than 3 dB variation in amplitude) near the marker before Signal Track was enabled as well as set the frequency of this point as the center frequency.

Search Para

Defines the conditions of peak search for various peak searching. A real peak should meet the value of both "PK Excursn" and "PK Thresh".

1. PK Excursn

Sets the excursion between the peak and the minimum amplitude on both sides of it. Peaks whose excursions are beyond the specified excursion are treated as real peaks.

Table 2-59 PK Excursn

Parameter	Explanation
Default	10 dB
Range	0 dB to 200 dB
Unit	dB
Knob Step	1 dB
Direction Key Step	1 dB

2. PK Thresh

Assigns a minimum for the peak amplitude. A real peak should always be beyond the limit you specified.

Table 2-60 PK Thresh

Parameter	Explanation
Default	-90 dBm
Range	-200 dBm to 0 dBm
Unit	dBm、-dBm、mV、uV
Knob Step	1 dBm
Direction Key Step	1 dBm

3. Peak Search

Sets the peak search condition. The available options are Maximum and Para.

- If **Max** is selected, the system searches for the maximum on the trace.
- If **Para** is selected, the system searches for the peak that meets the parameter condition on the trace.
- This setting has meaning only for the peak search which will be executed when pressing the **Peak** key on the front panel, while other searches such as Next Peak, Peak Right, Peak Left and Min Search are all based on the **Para** you specified.

Peak Table

Open the Peak Table, you will see a peak list that meets the parameter condition (with Frequency and Amplitude shown). The table allows up to 10 such peaks.

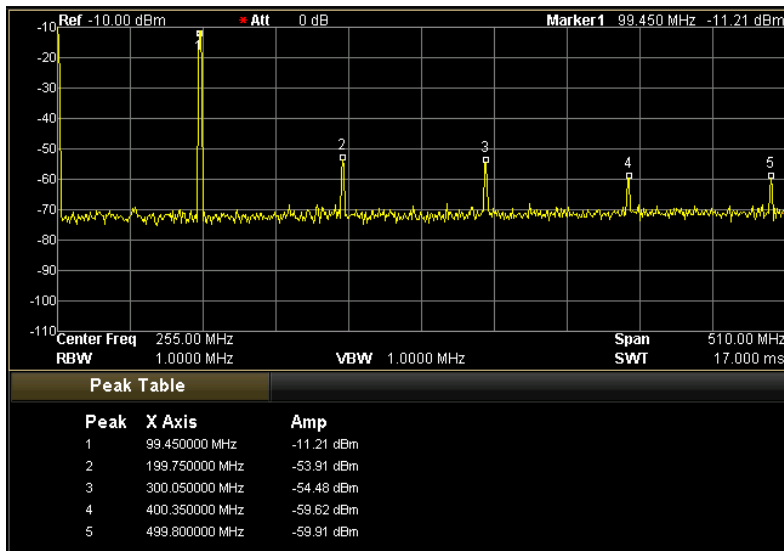

Figure 2-28 Peak Table

1. State

Turn on or off the Peak Table, the default is Off.

2. Peak Sort

Chooses a rule for peak sorting, the default is frequency ascending.

3. Pk Readout

Sets the peak display condition to Normal, >DL or <DL.

- Normal

Displaying the first ten qualified peaks in the table.

- >DL

Displaying the first ten peaks that not only meet the parameter conditions but also have an amplitude greater than the specified Display Line (from **Display** menu) in the table.

- <DL

Displaying the first ten peaks that not only meet the parameter conditions but

also have an amplitude smaller than the specified Display Line (from **Display** menu) in the table.

L-Peak

The shortcut key of the Left peak measurement, which has the same function as the **L-Peak** menu under the **Peak** key: Searches the nearest peak located to the left side of the current peak and meets the searching condition, and identifies it with a marker.

R-Peak

The shortcut key of the Right peak measurement, which has the same function as the **R-Peak** menu under the **Peak** key: Searches the nearest peak located to the right side of the current peak and meets the searching condition, and identifies it with a marker.

System Functions

System

System-related operations: Language, reset, calibration, I/O settings, reference source, probe power, front switch, coupling parameters, information, status, self-test, time/date and license.

Language

Selects the desired display language.

Reset

Selects the instrument settings to be recalled after the analyzer is powered on. The power on setting includes Last and Preset, and Preset has two types: Factory and User.

1. Power On

Sets the power on setting to Last or Preset.

- When **Last** is selected, settings before the last power-off would be recalled automatically when power on.
- When **Preset** is selected, settings defined in the **Preset Type** would be recalled automatically when power on.

2. Preset Type

Sets the preset type to factory or User. The preset will be recalled after the following operations:

- Start-up the analyzer when **Power On** setting is "Preset".
- Press **Preset**

3. Save Preset

Saves the current instrument settings as the user-defined setting into the internal non-volatile memory, and these settings will be recalled when the Preset Type is set to User.

Calibrate

1. Cal Now

The analyzer will use the internal calibration source to perform a self-test as soon as the menu key is pressed.

2. Self-Cal

This function drives the analyzer to perform a regular self-calibration according to the environmental temperature so as to compensate for the system error.

I/O Settings

This analyzer supports communications through the LAN, USB and GPIB interfaces. Both LAN and USB are standard interfaces, and GPIB should be configured by using a USB-GPIB module (option) provided by **RIGOL**. To get the USB-GPIB module, please contact **RIGOL**.

1. Remote I/O

Selects LAN, USB or GPIB, or disable all the three interfaces.

2. LAN

Sets or resets the LAN parameters.

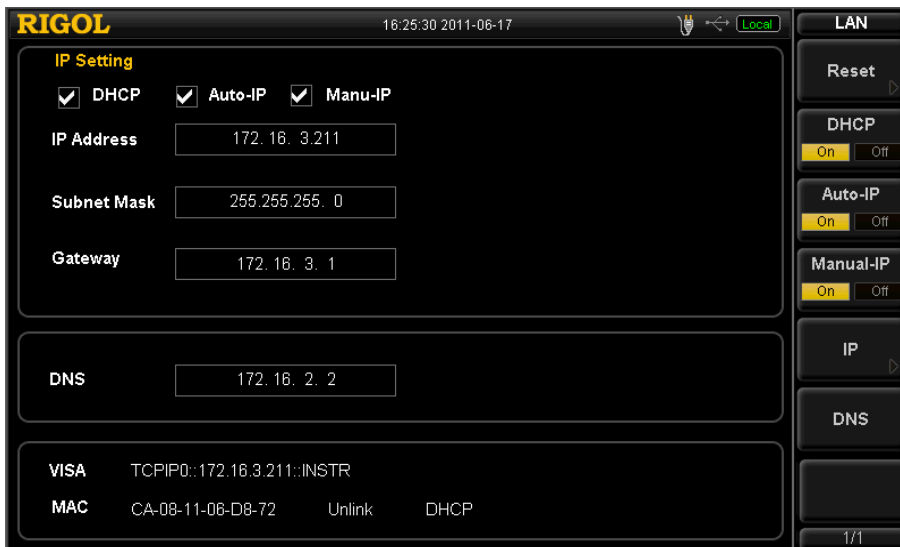

Figure 2-29 LAN parameter setting

The following items can be set through the front panel or remote interface.

- **Reset:** Turns on the DHCP and Auto-IP, turns Manual-IP off, and then clears the existing web password.
- **DHCP:** one of the setting methods of IP address. The DHCP server assigns an IP address, subnet mask and gateway to the analyzer on the basis of the current network status.
- **Auto-IP:** one of the setting methods of IP address. The analyzer obtains an IP address (from 169.254.0.1 to 169.254.255.254) and a fixed subnet mask 255.255.0.0 automatically.
- **Manual-IP:** one of the setting methods of IP address. In this type users can define a desired IP address for the analyzer.
- **IP:** Sets the IP address, subnet mask and gateway manually.
- **DNS:** Sets the IP address of the DNS server.

Note: The analyzer will always try to get an IP address in the order of DHCP, Auto-IP and Manual-IP. These three ways cannot be disabled at the same time.

3. USB

Sets the class and address of the USB slave device. The device class includes Auto Configure, TMC and Printer. The address is read-only and cannot be edited.

- **Auto Configure:** the type depends on the USB host device.
- **TMC:** uses the analyzer as a Test & Measurement Class device.
- **Printer:** uses the analyzer as a Printer Class device.

4. GPIB

Sets the GPIB address.

You can modify this parameter using the numeric keys, knob or direction keys. For more details, please refer to "**Parameter Input**".

Table 2-61 GPIB address

Parameter	Explanation
Range	0 to 30
Unit	N/A
Knob Step	1
Direction Key Step	1

Ref Source

Selects the internal or external reference source, the default is internal. The Reference source is used to synchronize all of the equipment clocks in this measurement system so as to decrease the frequency deviation.

1. Internal Reference Source

When internal reference source is in use, a reference signal that enables synchronization to other devices will be outputted from the **10 MHz IN/OUT** terminal at the rear panel.

2. External Reference Source

An external reference source at the **10 MHz IN/OUT** terminal at the rear panel can be used to synchronize the analyzer and other devices. In case of any loss, unconnected or over range issues in respect of the source, a message like "Ext Ref Invalid" will be shown in the status bar of the screen.

Probe Power

Turns on or off the probe power output at the terminal of **PROBE POWER**. This power is supplied with two lines: 15 V/150 mA and -12.6 V/150 mA.

Front Switch

Sets the status of the front switch, the default is On. If On is selected, you should press the power key at the front panel to start up the analyzer after turning on the rear switch, otherwise the analyzer will start after you turn on the power switch at the rear panel.

Coupl Param

Sets all related parameters automatically according to the coupling relationship.

Definitions of the coupling parameters:

1. CF Step

This parameter maintains a coupling relationship with the RBW (or span) in zero span (or non-zero span) mode. Refer to "**CF Step**" for more details.

2. Reference level

This parameter maintains a coupling relationship on the max mixing level with either the input attenuator or the preamplifier. Refer to **"Ref Level"** for more details.

3. Input Attenuation

This parameter maintains a coupling relationship on the max mixing level with either the reference level or the preamplifier. Refer to **"Ref Level"** for more details.

4. RBW

This parameter maintains a coupling relationship with the span. Refer to **"RBW"** for more details.

5. VBW

This parameter maintains a coupling relationship with the RBW. Refer to **"VBW"** for more details.

6. Sweep Time

This parameter maintains a coupling relationship with the RBW, VBW and span. Refer to **"Time"** for more details.

Information

Views the system information or messages recently shown on the screen.

1. System Information

- Model
- Serial Number
- Version of Radio Frequency Board
- Version of Digital Board
- Version of Radio Frequency Board FPGA
- Version of Digital Board FPGA
- Version of Embedded Software

2. System Message

Views the system messages that have appeared recently (up to 71 items). For more information about the system message, refer to “**Messages**”.

Status

1. Analyzer

Shows the basic setting information about the measurement, such as Frequency, Span, Amplitude, and Sweep Time.

2. Power

Shows the setting information related to the advanced measurement functions, such as T-Power, ACP, Chan Pwr, OBW, EBW, C/N Ratio, Harmo Dist, TOI and Pass/Fail.

3. TG

Shows the setting information related to the Tracking Generator.

4. Demod

Shows the setting information related to the Demod function.

5. Corrections

Shows the setting information related to the amplitude correction.

Self-Test

1. Screen Test

Tests if the screen has a dot defect by using five colors: White, Red, Green, Blue and Black.

2. Key Test

Tests if all the keys on the front panel work normally by pressing one by one. If the relative key shown from the interface of the analyzer lights when some panel-key is pressed, this indicates that the key you pressed is in normal service, or else an error may have occurred in this key.

Note: If the key at the front panel is transparent, its backlight will also light when you press it. To exit the testing, press **Esc** three times.

Time/Date

1. Time/Date

Enables or disables the Time/Date display.

2. Set Time

Sets the display time of the analyzer. The time format should be HHMMSS, for example, 231211 (denotes 23:12:11).

3. Set Date

Sets the display date of the analyzer. The date format should be YYYYMMDD, for example, 20091001 (denotes October 1st, 2009).

License

Enters the option management interface. You can use the knob to select the corresponding option and input the correct option license so as to install the option and enable the option function. Each option has a unique license and can only be used in the corresponding analyzer. For more information about the options, refer to **“Appendix A: Ordering Information”**.

1. Acquire the license

- 1) Order the corresponding option to acquire the option key.
- 2) Log in **RIGOL** website (www.rigol.com). Click “Customer Center” and select “License Generate” to enter the software license generation interface.
- 3) Input the option key, instrument serial number (press **System** → **Information** → **System Info** to acquire the instrument serial number) and identifying code; click “Generate” to get the corresponding option license.

2. Install the option

- 1) **License**
Press **License** to open the input box and input the option license using the numeric keys and knob at the front panel. For example, 646K204P69N0P0395P899156121M2M9OKO4L056728N399PO. After

entering all the characters, press **Save**. At this point, the Active bar is in inactive ("N") state.

2) **Active**

Press **Active** to activate the input option license. At this point, the Active bar is in active ("Y") state. The option is successfully installed.

Tip:

You can also install the option by operating the spectrum analyzer remotely.

1. Build the communication between the spectrum analyzer and PC. You can use the USB, LAN or GPIB (option) interface. For the connecting methods, refer to "**Remote Control**".
2. Send the :SYSTem:LKEY <option>,<license key> command. For example, :SYSTem:LKEY 0002,646K204P69N0P0395P899156121M2M9OKO4L056728N399PO. The spectrum analyzer recognizes the license received and matches it with the corresponding option. At this point, the corresponding option is installed and is in active state (the Active bar shows "Y").

Display

Controls the screen display of the analyzer, such as setting the display line, active function, hold time of the menu, graticule, screen saver, screen state, brightness, skin, and message switch.

Display Line

Turns on or off the display line, or changes its position. This line can be used as either the reference for you to read the measurement result, or the threshold value for the peaks displayed in the peak table.

Key Points:

- This line is a horizontal reference of which the amplitude is equal to the set value and the amplitude has the same unit with the selected unit from **Units**.
- You can modify this parameter using the numeric keys, knob or direction keys. For more details, please refer to "**Parameter Input**".

Table 2-62 Display line

Parameter	Explanation
Range	Current display amplitude range
Unit	dBm, dBmV, dBuV, V, W
Knob Step	Step = Scale/10 (Log scale type) Step = 0.1 dB (Lin scale type)
Direction Key Step	Step = Scale (Log scale type) Step = 1 dB (Lin scale type)

Active Fct

Selects the position in which the active function is displayed for convenient observation of the measurement result. Selectable positions are Top, Center and Bottom. Pressing **Esc** key closes the display of the active function.

Menu Hold

Sets the holdtime of the menu to 3s, 5s, 10s, 20s, or Infinite. The screen enters the Full screen after the specified hold time.

Graticule

Sets the brightness of the grid. This parameter can be used to highlight the display of the trace.

You can modify this parameter using the numeric keys, knob or direction keys. For more details, please refer to "**Parameter Input**".

Table 2-63 Graticule

Parameter	Explanation
Range	0 to 10
Unit	N/A
Knob Step	1
Direction Key Step	1

Scr Saver

Sets the latency before the screen enters the Screen Saver mode after the analyzer becomes idle. The latency can be 1 min, 15 mins, 30 mins, 1 hour or you can turn off the screen saver function. The pattern of the Screen Saver refreshes its display position per minute.

Scr State

Turns on or off the screen state, the default is On. If you select Off, a message like "The display was locked, please press Esc to unlock." will be given to prompt you that the screen has stopped refreshing to improve the measuring rate. In remote mode, the screen will always be locked.

Brightness

Sets the LCD brightness of the analyzer.

You can modify this parameter using the numeric keys, knob or direction keys. For more details, please refer to **“Parameter Input”**.

Table 2-64 Brightness setting

Parameter	Explanation
Range	0 to 7
Unit	N/A
Knob Step	1
Direction Key Step	1

Skin

Sets the skin to Classic or Modern.

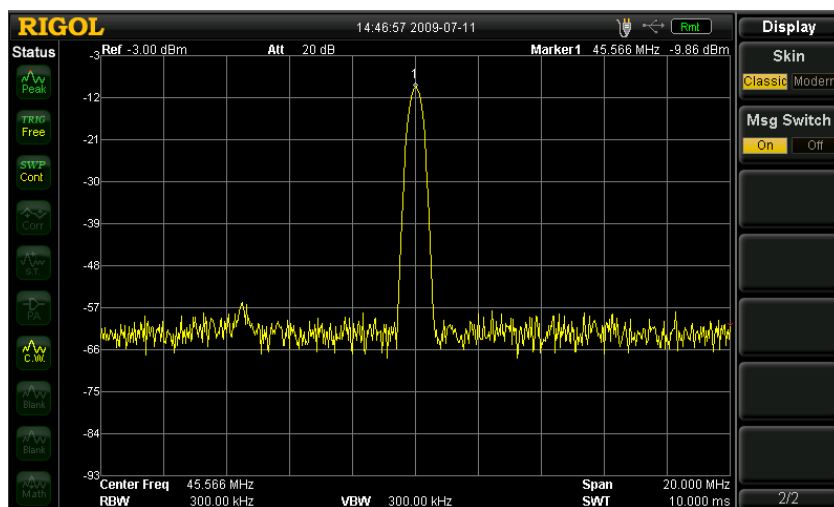

Figure 2-30 Classic display

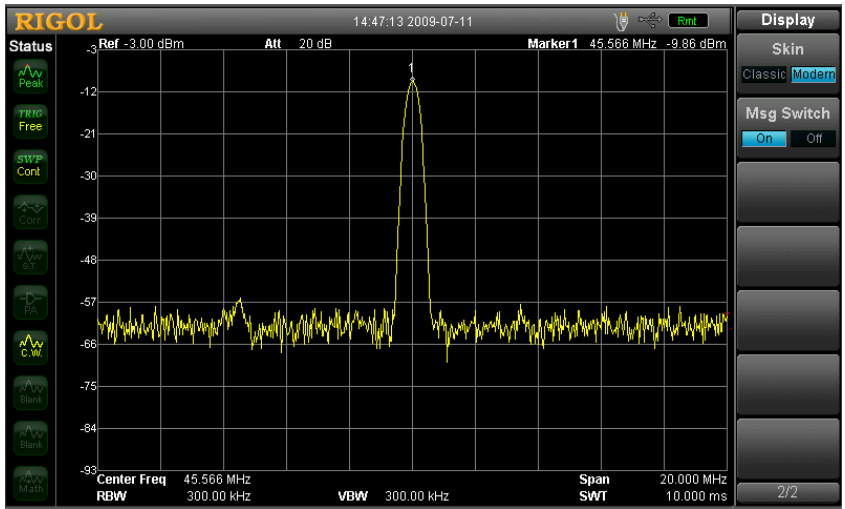

Figure 2-31 Modern display

Msg Switch

Enables or disables the display of messages. The types of messages in this analyzer include Information Message, Error Message and Status Message. Only Information Messages appear if the message switch is Off. For more details about messages, refer to "0 Messages".

Preset

Restores the analyzer to a specified status. This may change all parameters related to the sweep, the measurement function and the system.

Key Points:

- Press **System** → **Reset** → **Preset Type** to select **Factory** or **User**.
- Press **Preset** to load Factory settings (except for items marked with “**”) listed in the following table or User-defined settings.

Table 2-65 Factory Default

Parameter	Default
Frequency	
Center Freq	1.5 GHz
Start Freq	0 Hz
Stop Freq	3 GHz
CF Step	Auto, 300 MHz
Signal Track	Off
Span	
Span	3 GHz
Amplitude	
Ref Level	0 dBm
Ref Offset	0 dB
Scale/Div	10 dB
Input Atten	Auto, 10 dB
Scale Type	Log
Units	dBm
RF Preamp	Off
MaxMixL	-10 dBm
Corr	
Corrections	Off
Detector	
Detector Type	Pos Peak
Demod	
Demod	Off
Speaker	Off

Volume	100
Demod Time	100 ms
BW	
RBW	Auto, 1 MHz
VBW	Auto, 1 MHz
V/R Ratio	1
Filter Type	Gauss
Sweep	
Time	Auto, 100 ms
Auto SWT	Normal
Mode	Cont
Numbers	1
Points	601
Source**	
TG	Off
Power Sweep	Off
Ref Trace	Off
Freq Offset	0 Hz
TG Level	0 dBm
TG Lvl Offset	0 dB
Normalize	Off
Norm Ref Lvl	0 dB
Norm Ref Pos	100%
Trig	
Trig Type	Free Run
Trig Level	0 dBm
Edge	Positive
Measure	
Meas Fctn	Off
Meas Mode	Cont
Measure Setup	
T-Power	
Avg Num	Off, 10
Avg Mode	Exp
TP Type	Peak
Start Line	0 us

Stop Line	100 ms
ACP	
Avg Num	Off, 10
Avg Mode	Exp
Main CH BW	2 MHz
Adj CH BW	2 MHz
CH Spacing	2 MHz
Chan Power	
Avg Num	Off, 10
Avg Mode	Exp
Integ BW	2 MHz
CH Pwr Span	3 MHz
OBW	
Avg Num	Off, 10
Avg Mode	Exp
Max Hold	Off
OBW Span	2 MHz
Power Ratio	99%
EBW	
Avg Num	Off, 10
Avg Mode	Exp
Max Hold	Off
EBW Span	2 MHz
EBW X dB	-10 dB
C/N Ratio	
Avg Num	Off, 10
Avg Mode	Exp
Offset Freq	2 MHz
Noise BW	2 MHz
Carrier BW	2 MHz
Harmo Dist	
Avg Num	Off, 10
Avg Mode	Exp
NO.of Harmo	10
Harmonic ST	10 ms
TOI	

Avg Num	Off, 10
Avg Mode	Exp
TOI Span	2 MHz
Pass/Fail	
Limit	Upper
Test	Off
Point	1
X-axis	Freq
Connected	No
Freq Interp	Lin
Fail Stop	On
Trace	
Select Trace	1
Trace Type of Trace 1	Clear Write
Avg Times	100
Function	A-B
A	T1
B	T2
Const	0
Math Operate	Off
Marker	
Select Mkr	1
Mkr Type	Normal
Mkr Trace	Auto
Readout	Frequency
Mkr Table	Off
Peak	
Cont Peak	Off
Peak Search	Max
Pk Excursn	10 dB
Pk Thresh	-90 dBm
Peak Table	Off
Peak Sort	Freq
Pk Readout	Normal
Marker Fctn	
Mkr Fctn	Off

N dB BW	-3 dB
State	Off
Resolution	Auto, 1 kHz
System*	
I/O Setting	Off
DHCP	On
Auto-IP	On
Manual-IP	Off
USB Dev Class	TMC
GPIB Address	18
Ref Source	Int
Probe Power	Off
Front Switch	On
Information	System Info
Status	Analyzer
Time/Date	On
Self-Cal	On
Storage*	
File Type	State
Format	BIN
File Source	T1
Browser	Dir
Input Style	English
Prefix Name	Off
Display*	
Display Line	Off, 0 dBm
Active Fctn	Top
Graticule	5
Menu Hold	Infinite
Scr Saver	Off
Scr State	On
Brightness	6
Skin	Classic
Msg Switch	On
Print*	
Orientation	Landsc

Page Size	Default
Inverted	Off
Palette	Gray
Copies	1
Date Prints	Off
Qualities	Default
File Type	Default

Note:

*Not affected by preset.

**Only applicable to DSA1030A-TG.

Storage













Instrument settings and waveform data can be saved to or loaded from files in the internal memory of the analyzer or external USB storage devices. Press **Storage** to enter the file operation manager, see figure below.



Figure 2-32 File operation manager

Icons in the manager are:

Table 2-66 File icons

Icon	Explanation	Icon	Explanation
	Disk		CSV file
	A closed folder		Marker table file
	An opening folder		Setting file
	Unknown file		Trace file
	Bitmap file		Status file
	Amplitude correction file		Limit file

File Type

The analyzer can make files such as Setting file, Status file, Trace file, Amplitude correction file, Measurement data, Marker table file, Peak table file and Limit file. For the details about each file, see table below.

Note:

- 1) The status file stores all the instrument settings that will be affected by preset (refer to Table 2-65); the setting file not only stores the instrument settings that will be affected by preset, but also stores the amplitude correction table (the frequency and amplitude of the correction point), the trace data currently used (at most 4) and the marker information (marker readout mode, marker readout and display state).
- 2) The measurement data, marker table and peak table files can only be stored when the corresponding functions are enabled.

Table 2-67 File type

File Type	Format	Extension
Setting	BIN	.set
Status	BIN	.sta
Trace	BIN	.trc
	CSV	.csv
Amplitude correction	BIN	.cbl
	CSV	.csv
Measurement data	CSV	.csv
Marker table	BIN	.mkr
	CSV	.csv
Peak table	CSV	.csv
Limit	BIN	.lim

Format

Sets the storage format of the measurement data to BIN (default) or CSV. BIN is a binary format while CSV is a character file that can be read by Excel.

File Source

Sets the file source of the storage to T1, T2, T3, Math Trace or All.

Note that this menu is available only when the **File Type** is set to Trace and the Format is set to CSV.

Browser

Sets the browser type. You can switch between directory and file by using the direction keys or the knob.

Save

Saves a file into the external or internal memory. Note that the length of a filename is limited to a maximum of 48 characters.

Expand Dir

Expands the directories.

Collapse Dir

Collapses the directories.

Recall

Reads the selected file and loads it into the system.

Rename

Renames a stored file.

Delete

Deletes the selected file.

Copy

1. Copy From

Copies files or folders.

- When "Dir" is selected in **Browser**, pressing this key will copy all files or folders in the current path.
- When "File" is selected in **Browser**, pressing this key will copy the selected file or folder.

2. Copy To

Performs the paste operation of a directory or file.

Note: When the current directory already contains a file or folder with the same name, a backup copy will be created with the prefix "Dup" after executing the paste operation.

3. Browser

A shortcut key. Refer to "**Browser**".

4. Expand Dir

A shortcut key. Refer to "**Expand Dir**".

5. Collapse Dir

A shortcut key. Refer to "**Collapse Dir**".

Create Dir

Creates a directory in the current path. Note that the length of a directory name is limited to a maximum of 48 characters.

Disc Mgr

1. Format (D:)

Formats the local disk.

2. Disk Info

View the disk information such as disk name, disk type (local or USB storage device), file system, the used space and the total space.

Name Prefix

1. Prefix Switch

Enables or disables the edited prefix name. The input box will automatically load the prefix name after you press **Save** when **Prefix Switch** is set to On.

2. Edit

Edits the required prefix name by using the virtual keyboard. Up to 15 characters can be entered.

System Update

Updates the analyzer software after selecting the update file in the connected USB storage device.

Print Setup

Sets the print parameters. The analyzer supports a PictBridge printer. To use the print function, connect this printer with the analyzer as shown in the figure below, and then press **System** → **I/O Setting** → **USB** → **Dev Class** → **Printer** to enable the analyzer to be a Printer Class device and set desired print parameters; then press **Print** to print out the measurement data that you want.

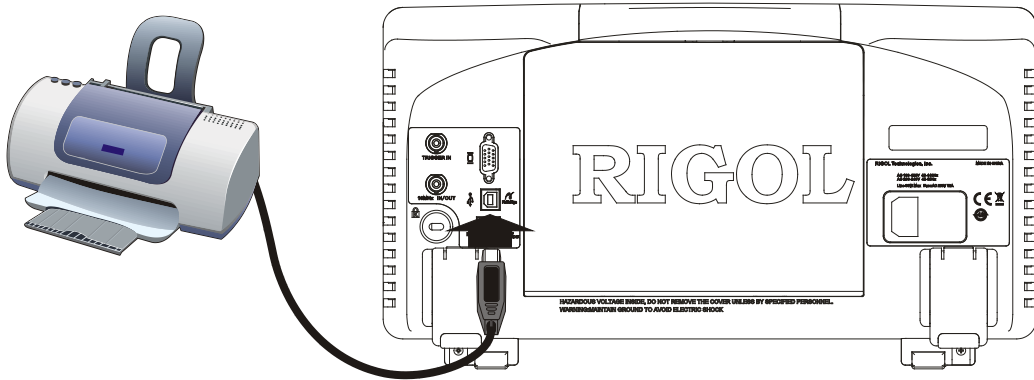





Figure 2-33 PictBridge printer connection

Printing Procedures:

- (1) Turns on the PictBridge printer and waits for the initialization.
- (2) Uses the USB cable provided in the accessories to connect the analyzer with the PictBridge printer.
- (3) Then a message like “PictBridge printer connected.” is shown on the screen to prompt you that the instrument now is initializing the driver and the printer module.
- (4) When installation is finished, a message like “PictBridge printer installed successfully.” will be displayed on the screen so that you can start the print job.
- (5) Before printing, the analyzer always changes the sweep mode to Single and stops sweeping in order to save the frozen measurement result.
- (6) The printer symbol, print state and process are shown on the status bar of the screen during printing.
- (7) You can pause and resume the printing if necessary.
- (8) The printer enters the idle state and waits for the next task after a successful print job.

Table 2-68 The printing state icons

Icon	Explanation
	The two icons display alternately, indicating that the printer now is connecting.
	Successful connection, print finished or idle.
	The two icons display alternately, indicating the print job is in progress.
	Print has been paused.

Print

Prints the measurement data according to current setting parameters when the printer has been successfully installed and is in idle state.

Resume

Resumes the print job that has been paused.

Cancel

Ends the current print job without completing it.

Orientation

Selects the print orientation to Landscape or Portrait.

Page Size

Selects a page size from A4, A5, A6, B5 or Default. The default size depends on the printer currently connected.

Inverted

Turns on or off the inverted printing.

Palette

Selects a print color from Gray and Color printing.

Copies

Sets the print copies. Note the analyzer allows for up to 999 copies to be printed at one time.

Date Prints

Turns on or off the date print.

Qualities

Selects print quality to Normal, Draft, Fine or Default. The default quality depends on the printer under use.

Hint

“Fine” printing may consume more ink than other print quality settings.

File Type

Sets the printing file type to Default or Exif/JPEG. The default type depends on the printer currently in use.

Hint

The analyzer can automatically identify the characteristics of the printer, such as Page size, during the printer installation. If some configuration is not supported by the current printer, the corresponding menu in the analyzer is invalid. For example, if the current printer does not support color printing, the "Color" option in Palette menu is invalid.

Print

Presses  to save or print the current screen.

Key Points:

- This operation prints out the current screen according to the print settings when a printer is connected.
- When no printer is connected but an USB storage device is detected, this operation saves the current screen with the specified file name to the root directory of USB storage device.
- If neither a printer nor a USB storage device is successfully connected, this operation saves the current screen data with the specified filename in the local disk (D:). Then, you can copy the file to the USB storage device and save the file into the PC.

Screen Control

Switches to the desired window and zooms it in or switches to full screen display in Multiwindow display.

Full Screen

Presses  to switch the screen into full screen mode. In this mode, neither the menus on the right side nor the parameter status on the left side of the screen would be displayed (see figure below) so that you can view the trace more clearly. To exit full mode, press this key again.

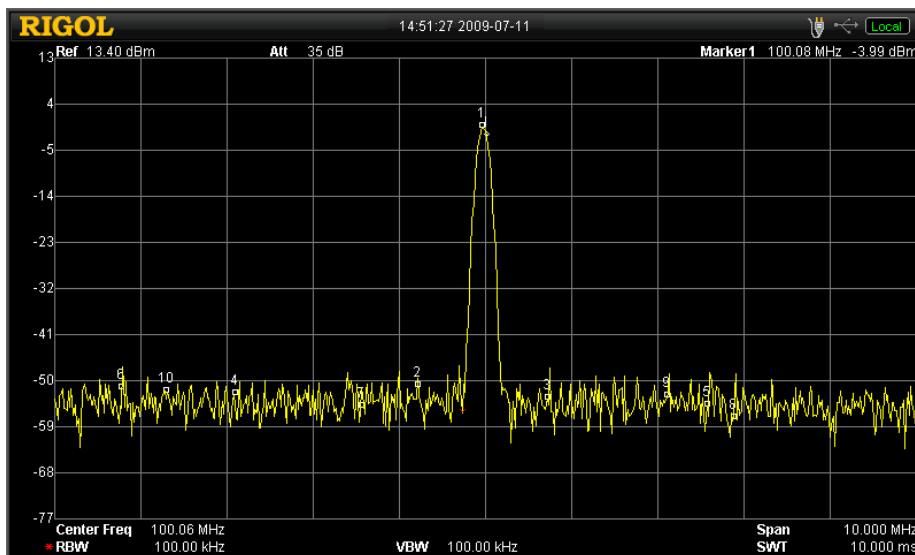



Figure 2-34 Full screen display

Key Points:

- Pressing any function key (except **Single**, **Continue**, **L-Peak** and **R-Peak**), menu, or  again will exit full screen mode.
- Full screen state will remain unchanged when entering parameters so that you can observe how the measurement data changed according to the new parameter.
- The pixel count of the grid area is 751 in full screen and 601 in non-full screen mode.

Next Window

Press  continuously to select one of the two windows alternately. The selected window is highlighted, see figure below.

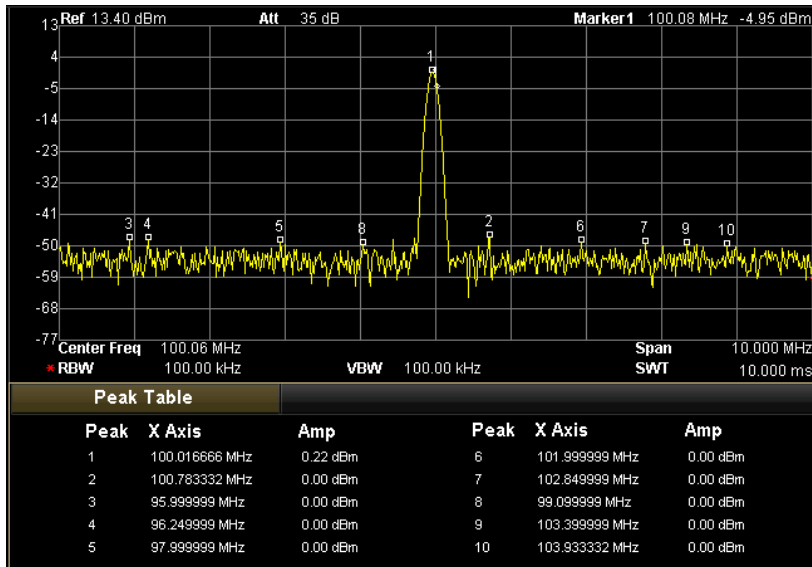





Figure 2-35 Switch between windows

Key Points:

- Pressing  (described in the following section) will zoom in on the selected window so that you can observe the trace or measurement data more clearly.
- If a window is zoomed in and the display has been in Multiwindow mode, continuously pressing  will display the two windows alternately.

Zoom

Zooms in the selected window by pressing .

The selected window will be zoomed in at the first press of this key. To exit this mode, press this key again.

Hint

The screen can be divided into two windows when one of these functions is enabled: Marker table, Peak table, correction table or one of the advanced functions in **Meas**.

Chapter 3 Measurement Examples

This chapter introduces the main functions and operations of the analyzer.

Subjects in this chapter:

- Measuring a Sine Signal
- Using the Frequency Counter
- Measuring an AM Signal
- Measuring the Phase Noise
- Measuring the N dB Bandwidth
- Measuring the Time-Domain Power
- Measuring the Adjacent Channel Power
- Measuring the Channel Power
- Measuring the Occupied Bandwidth
- Measuring the Emission Bandwidth
- Measuring the Carrier-to-Noise Ratio
- Measuring the Harmonic Distortion
- Measuring the TOI Distortion
- Pass/Fail Measurement
- Amplitude Correction
- Tracking Generator (DSA1030A-TG)

Measuring a Sine Signal

The most basic task of an analyzer is measuring the frequency and amplitude of a signal. In the example below, we use a generator (such as RIGOL DG3101A) to output a sine signal at 100 MHz and -10 dBm and we will use this as the signal to measure.

Procedures:

1. Device attachment

Connect the output terminal of the generator to the **RF INPUT 50Ω** terminal on the front panel of the analyzer.

2. Use Marker to measure

- (1) Reset the analyzer
 - Press **Preset**
- (2) Set the parameters
 - Press **FREQ**
 - Press **Center Freq** and enter 100 MHz.
 - Press **SPAN**
 - Press **Span** and enter 10 MHz.

- (3) User the marker

— Press **Marker**

A marker is activated.

— Press **Peak**

The peak is identified by a marker, and the frequency and amplitude of this signal are displayed at the top right of the grid.

3. Measurement result

The frequency and amplitude of the signal under measure is 100 MHz and -10.05 dBm, see figure below.

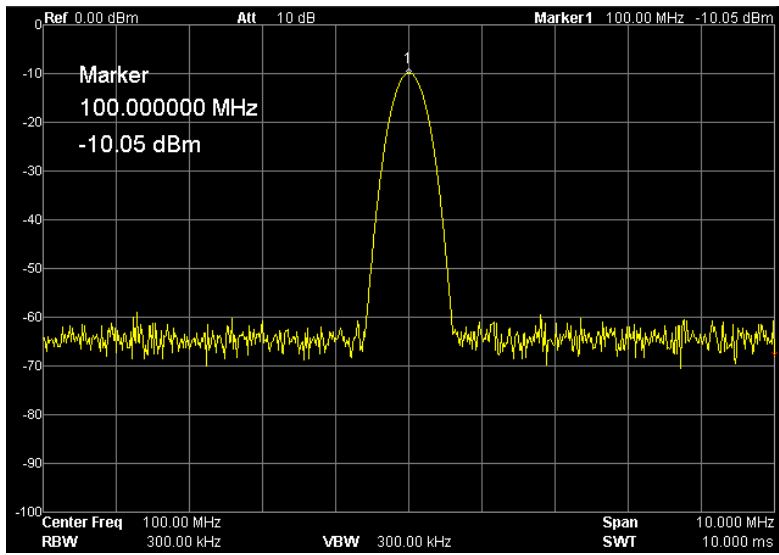

Figure 3-1 Measuring a Sine signal

Using the Frequency Counter

In order to get the precision frequency of the signal, the analyzer provides a frequency counter that is a much more precise frequency measurement than the Marker. In the example below, we use a generator (such as RIGOL DG3101A) to output a sine signal with 100 MHz and -10 dBm as the signal under measure.

Procedures:

1. Device attachment

Connect the output terminal of the generator to the **RF INPUT 50Ω** terminal on the front panel of the analyzer.

2. Use the frequency counter to measure

(1) Reset the analyzer

— Press **Preset**

(2) Set the parameters

— Press **FREQ**

— Press **Center Freq** and enter 100 MHz.

— Press **SPAN**

— Press **Span** and enter 10 MHz.

(3) Open a marker

— Press **Marker**

A marker is activated.

— Press **Peak**

The peak is identified by a marker, and the frequency and amplitude of this signal are displayed at the top right of the grid.

(4) Use the frequency counter to measure

— Press **Marker Fctn**

— Press **Freq Count** and enter the lower menu.

— Press **State-On → On**, and the frequency will be shown in the active area and the top right corner of the grid.

(5) Set the measuring resolution of the Counter

— Press **Resolution** and enter 1 Hz.

3. Measurement result

The result is 99.998459 MHz (with an accuracy of 1 Hz), see figure below.

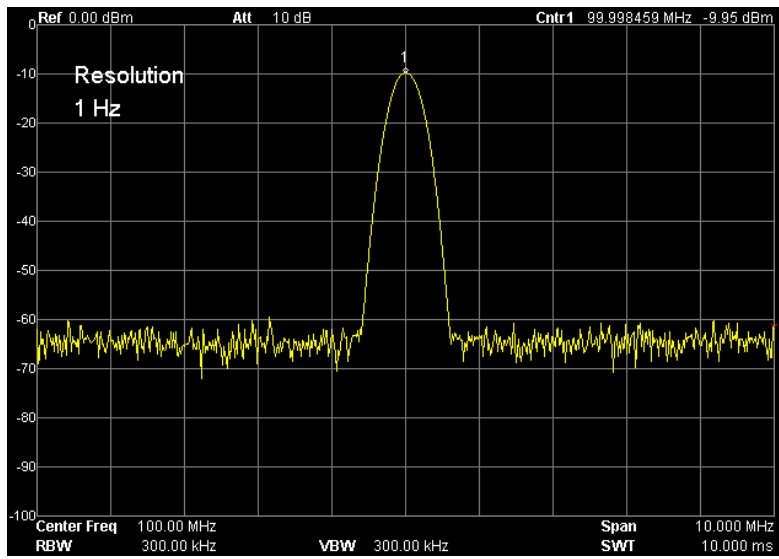

Figure 3-2 Use the frequency counter to measure

Measuring an AM Signal

Through the demodulation function, the AM modulating signal can be separated from the carrier and displayed on the screen. In the example below, we use a generator (such as RIGOL DG3101A) to output an AM modulating signal as the signal under measure: the carrier is a sine wave with 100 MHz and -10 dBm, the modulating frequency is 1 kHz, while the modulation depth is 100%.

Method 1: (in Zero Span)

Procedures:

1. Device attachment

Connect the output terminal of the generator to the **RF INPUT 50Ω** terminal on the front panel of the analyzer.

2. Measuring in zero span

(1) Reset the analyzer

— Press **Preset**

(2) Set the parameters

— Press **FREQ**

— Press **Center Freq** and enter 100 MHz.

— Press **SPAN**

— Press **Zero Span** and set the span of frequency as 0 Hz.

— Press **Sweep**

— Press **Time** and enter 10 ms in Manual mode.

(3) Use the marker to measure

— Press **Single**

— Press **Peak**

— Press **Marker**

— Press **Delta**

— Page down

— Press **Readout** and enter the lower menu.

— Press **1/Δ time**

— Press **R-Peak** or **L-Peak**

Also, you can press **Peak** → **Peak Right** or **Peak Left** to view the peaks at both sides.

—Read the frequency of the marker, that is the frequency of the modulating signal.

3. Measurement result

The result is -1 kHz, see figure below.

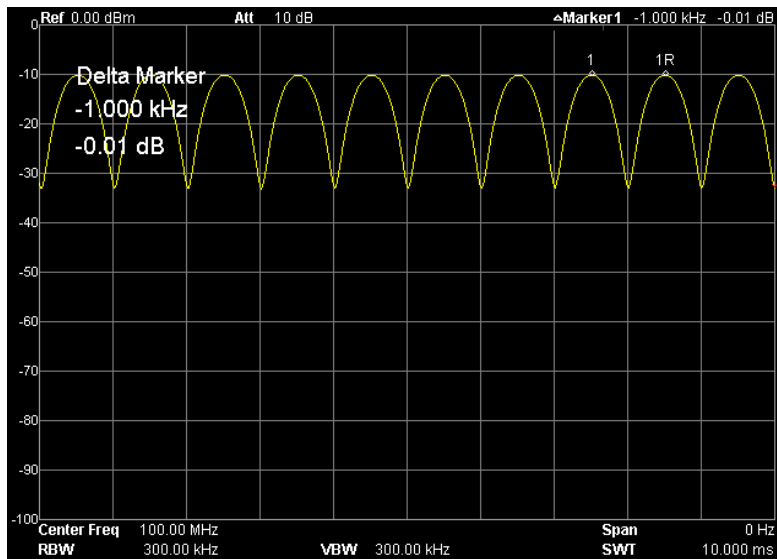

Figure 3-3 Measure an AM signal

Method 2: (Use AM demodulation function)

Procedures:

- (1) Reset the analyzer
 - Press **Preset**
- (2) Set the parameters
 - Press **FREQ**
 - Press **Center Freq** and enter 100 MHz.
 - Press **SPAN**
 - Press **Span** and enter 10 MHz.
- (3) Demodulate the signal
 - Press **Demod**
 - Press **Demod** and enter the lower menu.
 - Press **AM** to turn on AM demodulation function.
The frequency can be described by the acuity level of the speaker.
- (4) Set the parameters of AM demodulation function
 - Press **Demod Setup** and enter the lower menu.
 - Press **Speaker** to select whether or not to use the speaker under this function.
 - Press **Demod Time** and set the desired demodulating time.

Measuring the Phase Noise

The analyzer gives an easy way to measure the phase noise. In the example below, we use a generator (such as RIGOL DG3101A) to output a sine signal with 50 MHz and -10 dBm as the signal under measure.

Procedures:

1. Device attachment

Connect the output terminal of the generator to the **RF INPUT 50Ω** terminal on the front panel of the analyzer.

2. User the noise marker to measure

(1) Reset the analyzer

—Press **Preset**

(2) Set the parameters

—Press **FREQ**

—Press **Center Freq** and enter 50 MHz.

—Press **SPAN**

—Press **Span** and enter 50 kHz.

—Press **BW**

—Press **RBW** and enter 1 kHz.

—Press **VBW** and enter 100 Hz.

(3) Measure the phase noise

—Press **Peak**

Execute the peak searching and activate a marker.

—Press **Marker**

—Press **Delta** and enter 10 kHz.

Measure the amplitude attenuation that deviates 10 kHz from the signal.

—Press **Marker Fctn**

—Press **Noise Mkr**

3. Measurement result

The measured amplitude attenuation of the signal whose frequency deviates 10 kHz is -79.85 dB/Hz, see figure below.

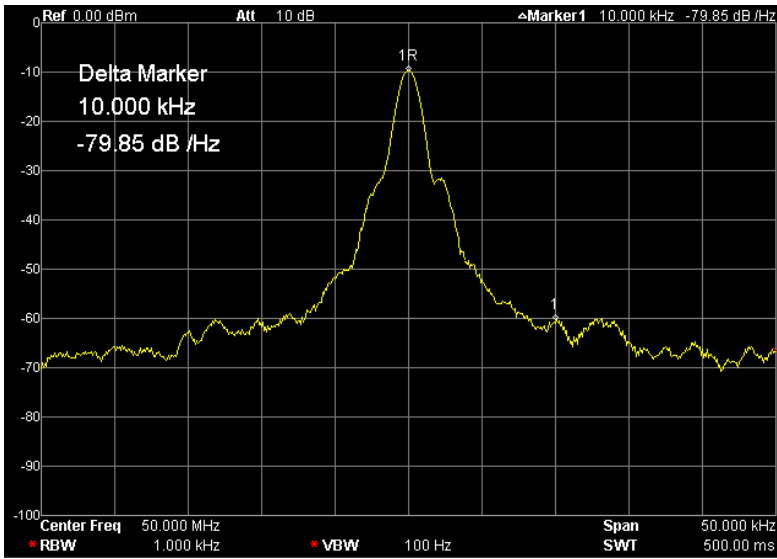

Figure 3-4 Phase noise measurement

Measuring the N dB Bandwidth

In the example below, we use a generator (such as RIGOL DG3101A) to output a sine signal with 100 MHz and -10 dBm as the signal under measure.

Procedures:

1. Device attachment

Connect the output terminal of the generator to the **RF INPUT 50Ω** terminal on the front panel of the analyzer.

2. Use the N dB bandwidth measurement function

(1) Reset the analyzer

—Press **Preset**

(2) Set the parameters

—Press **FREQ**

—Press **Center Freq** and enter 100 MHz.

—Press **SPAN**

—Press **Span** and enter 2 MHz.

(3) Use the N dB bandwidth measurement function

—Press **Marker Fctn**

A marker will be activated if no Marker has been turned on before.

—Press **N dB BW** and enter 3 dB.

3. Measurement result

From the active area shown below, we can see that the bandwidth of the two points where the signal degrades 3 dB from the current marker is 303.333 kHz.

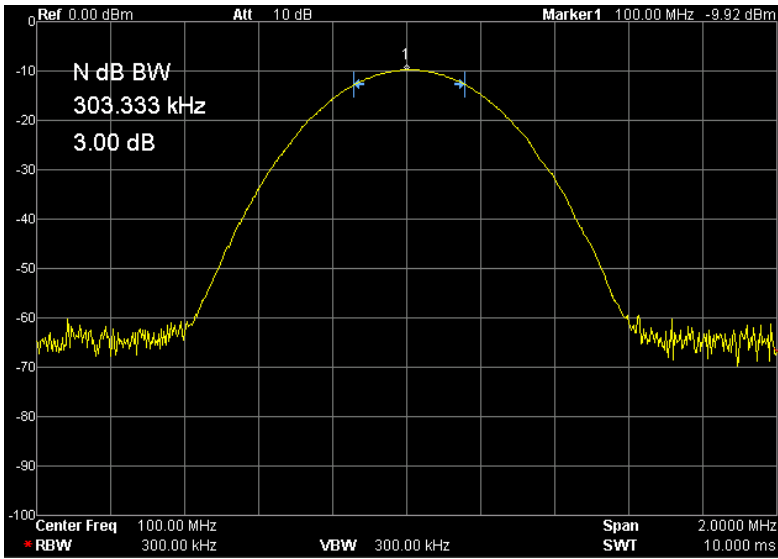

Figure 3-5 N dB bandwidth measurement result

Measuring the Time-Domain Power

The analyzer can measure the time-domain power such as the transmitted power in TDMA. In the example below, we use a generator (such as RIGOL DG3101A) to output a sine signal with 100 MHz and -10 dBm as the signal under measure.

Procedures:

1. Device attachment

Connect the output terminal of the generator to the **RF INPUT 50Ω** terminal on the front panel of the analyzer.

2. Measure the time-domain power

(1) Reset the analyzer

—Press **Preset**

(2) Set the parameters

—Press **FREQ**

—Press **Center Freq** and enter 100 MHz.

—Press **Meas**

—Press **Meas Fctn** and enter the lower menu.

—Press **T-Power**

Read the measuring result from the measurement frame at the lower left corner.

(3) Modify the time power settings

—Press **Meas Setup**

—Press **Peak**

—Press **Start Line** and enter 1 ms.

—Press **Stop Line** and enter 9 ms.

3. Measurement result

The measurement result shown in the lower window is -9.95 dBm, see figure below.

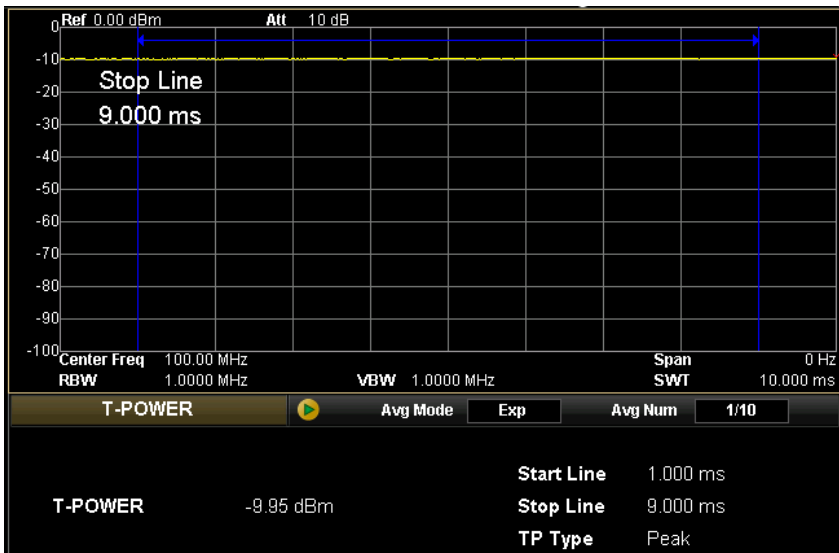

Figure 3-6 Time-domain power measurement

Measuring the Adjacent Channel Power

In the example below, we use a generator (such as RIGOL DG3101A) to output a sine signal with 100 MHz and -10 dBm as the signal under measure.

Procedures:

1. Device attachment

Connect the output terminal of the generator to the **RF INPUT 50Ω** terminal on the front panel of the analyzer.

2. Measure the adjacent channel power

(1) Reset the analyzer

—Press **Preset**

(2) Set the parameters

—Press **FREQ**

—Press **Center Freq** and enter 100 MHz.

—Press **Meas**

—Press **Meas Fctn** and enter the lower menu.

—Press **Adj CH BW**

(3) Modify the adjacent channel power settings

—Press **Meas Setup**

—Press **Main CH BW** and enter 2 MHz.

—Press **Adj CH BW** and enter 2 MHz.

—Press **CH Spacing** and enter 2 MHz.

3. Measurement result

The measurement results shown in the lower window are:

Main channel power: -9.55 dBm

Upper channel power: -57.85 dBm, difference with the main channel: -48.30 dBc

Lower channel power: -57.46 dBm, difference with the main channel: -47.91 dBc

See figure below.

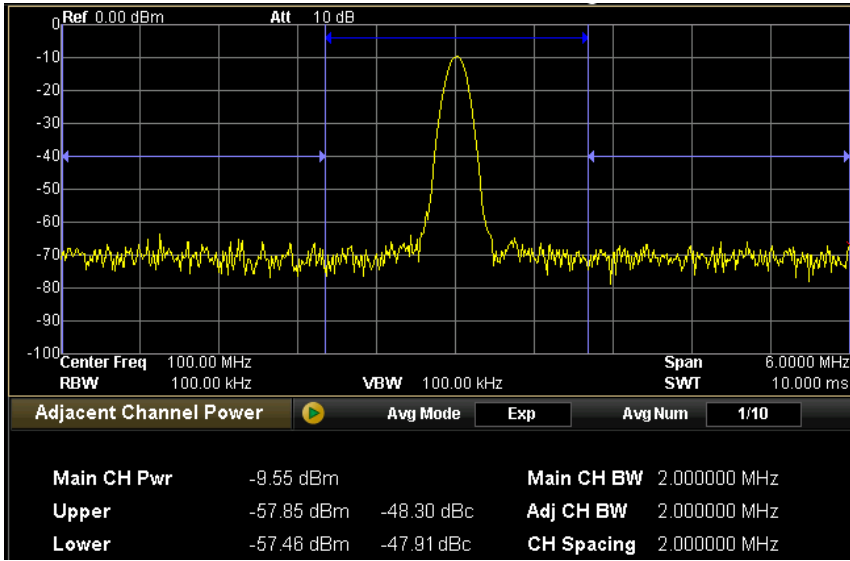

Figure 3-7 Adjacent channel power measurement result

Measuring the Channel Power

In the example below, we use a generator (such as RIGOL DG3101A) to output a sine signal with 100 MHz and -10 dBm as the signal under measure.

Procedures:

1. Device attachment

Connect the output terminal of the generator to the **RF INPUT 50Ω** terminal on the front panel of the analyzer.

2. Measure the channel power

(1) Reset the analyzer

—Press **Preset**

(2) Set the parameters

—Press **FREQ**

—Press **Center Freq** and enter 100 MHz.

—Press **Meas**

—Press **Meas Fctn** and enter the lower menu.

—Press **Chan Pwr**

(3) Modify the channel power settings

—Press **Meas Setup**

—Press **Integ BW** and enter 1 MHz.

—Press **CH Pwr Span** and enter 2 MHz.

3. Measurement result

The measurement results shown in the lower window are -9.61 dBm (channel power) and -69.61 dBm/Hz (power spectral density), see figure below.

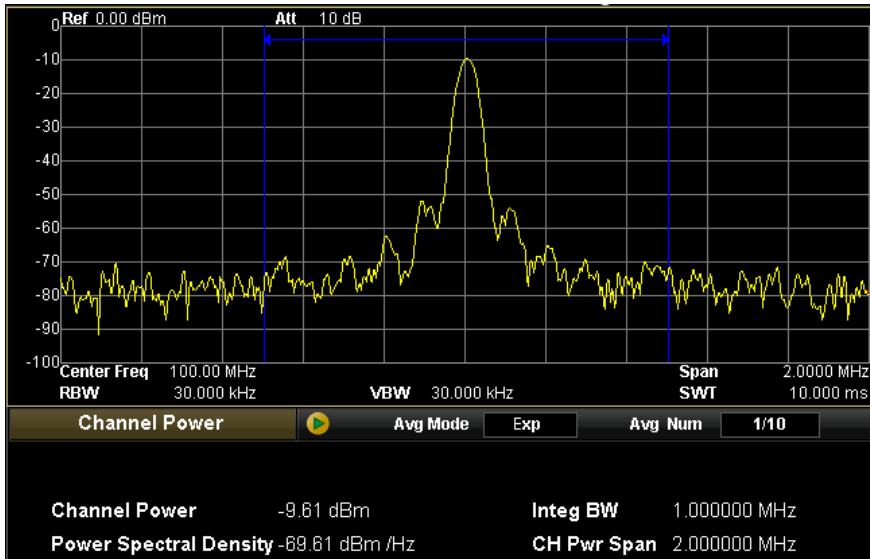

Figure 3-8 Channel power measurement result

Measuring the Occupied Bandwidth

In the example below, we use a generator (such as RIGOL DG3101A) to output a sine signal with 100 MHz and -10 dBm as the signal under measure.

Procedures:

1. Device attachment

Connect the output terminal of the generator to the **RF INPUT 50Ω** terminal on the front panel of the analyzer.

2. Measure the power distribution

(1) Reset the analyzer

—Press **Preset**

(2) Set the parameters

—Press **FREQ**

—Press **Center Freq** and enter 100 MHz.

—Press **Meas**

—Press **Meas Fctn** and enter the lower menu.

—Press **OBW**

(3) Modify the occupied bandwidth settings

—Press **Meas Setup**

—Press **OBW Span** and enter 2 MHz.

—Press **Power Ratio** and enter 99%.

3. Measurement result

The measurement results shown in the lower window are 53.333 kHz (Occupied bandwidth) and 0 Hz (Transmit frequency error), see figure below.

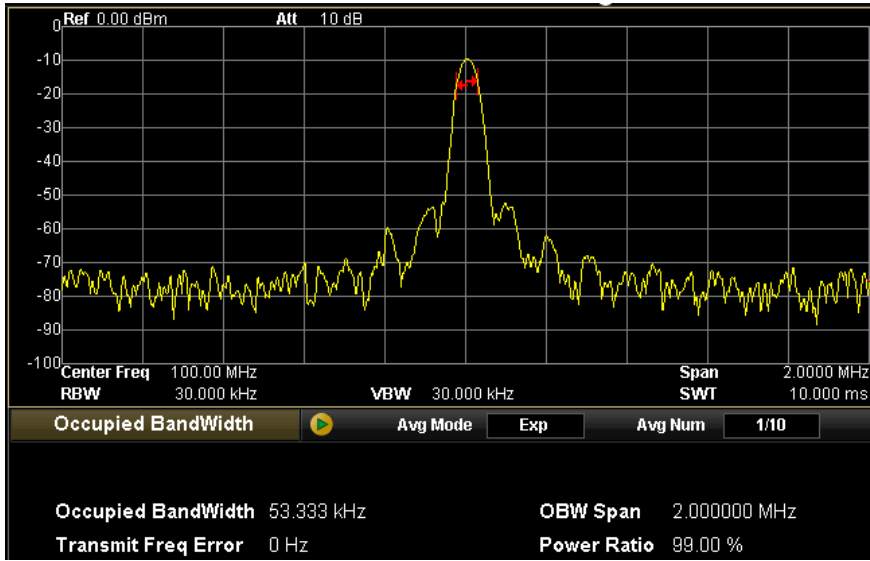

Figure 3-9 Occupied bandwidth measurement result

Measuring the Emission Bandwidth

In the example below, we use a generator (such as RIGOL DG3101A) to output a sine signal with 100 MHz and -10 dBm as the signal under measure.

Procedures:

1. Device attachment

Connect the output terminal of the generator to the **RF INPUT 50Ω** terminal on the front panel of the analyzer.

2. Measure the emission bandwidth

- (1) Reset the analyzer
 - Press **Preset**
- (2) Set the parameters
 - Press **FREQ**
 - Press **Center Freq** and enter 100 MHz.
 - Press **Meas**
 - Press **Meas Fctn** and enter the lower menu.
 - Press **EBW**
- (3) Modify the emission bandwidth settings
 - Press **Meas Setup**
 - Press **EBW Span** and enter 2 MHz.
 - Press **X dB** and enter -3 dB.
 - Press **BW**
 - Press **RBW** and enter 300 kHz.

3. Measurement result

The measurement result shown in the lower window is 303.33 kHz, see figure below.

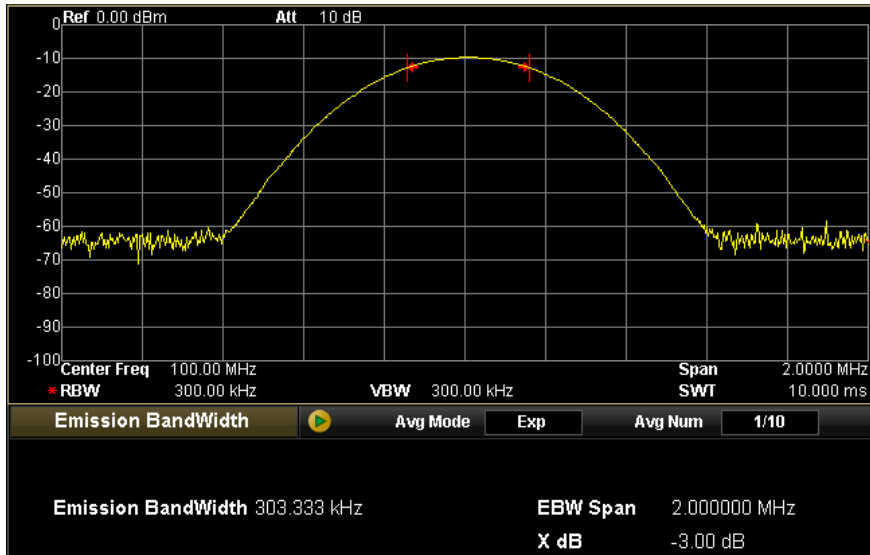

Figure 3-10 Emission bandwidth measurement result

Measuring the Carrier-to-Noise Ratio

In the example below, we use a generator (such as RIGOL DG3101A) to output a sine signal with 100 MHz and -10 dBm as the signal under measure.

Procedures:

1. Device attachment

Connect the output terminal of the generator to the **RF INPUT 50Ω** terminal on the front panel of the analyzer.

2. Measure the signal over the C/N Ratio function

(1) Reset the analyzer

—Press **Preset**

(2) Set the parameters

—Press **FREQ**

—Press **Center Freq** and enter 100 MHz.

—Press **Meas**

—Press **Meas Fctn** and enter the lower menu.

—Press **C/N Ratio**

(3) Modify the C/N Ratio settings

—Press **Meas Setup**

—Press **Offset Freq** and enter 2 MHz.

—Press **Noise BW** and enter 2 MHz.

—Press **Carrier BW** and enter 2 MHz.

3. Measurement result

The measurement results shown in the lower window are -9.55 dBm (carrier power), -57.92 dBm (noise power) and 48.37 dB (C/N Ratio), see figure below.

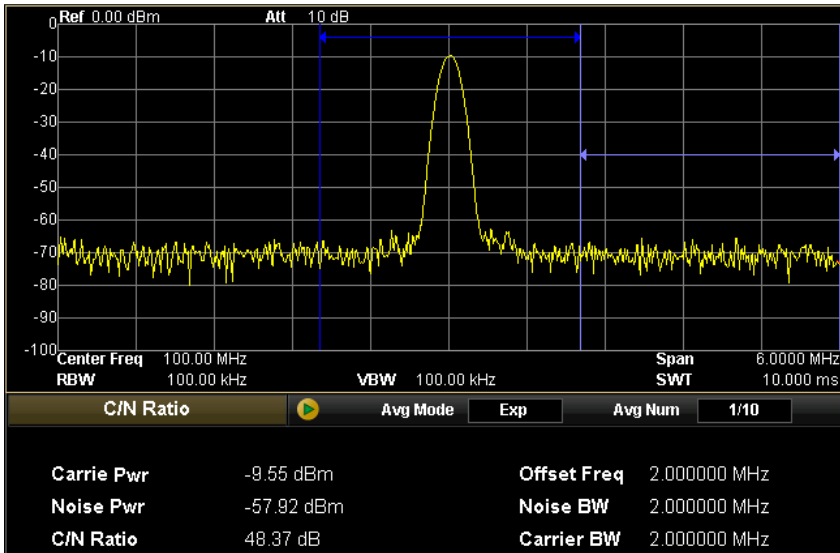

Figure 3-11 C/N Ratio measurement result

Measuring the Harmonic Distortion

In the example below, we use a generator (such as RIGOL DG3101A) to output a sine signal with 100 MHz and -10 dBm as the signal under measure.

Method 1: (Use marker function to measure)

Procedures:

1. Device attachment

Connect the output terminal of the generator to the **RF INPUT 50Ω** terminal on the front panel of the analyzer.

2. Use marker to measure

(1) Reset the analyzer

—Press **Preset**

(2) Set the parameters

—Press **FREQ**

—Press **Center Freq** and enter 200 MHz.

—Press **Stop Freq** and enter 400 MHz.

—Press **BW**

—Press **RBW** and enter 100 kHz.

Now, you can see the fundamental wave, the second harmonic, and third harmonic of the signal.

(3) Use the **Peak** and **Marker** functions to measure

—Press **Peak**

Execute peak searching and activate a marker whose fundamental wave is marked with frequency of 100 MHz and amplitude of -10 dBm.

—Press **Marker**

—Press **Delta**

—Press **Peak**

—Press **Next Peak**

The "Ref" of the marker is then placed at the fundamental wave while the "Delta" is at the second harmonic. The measured value would be: the frequency offset is 100 MHz and the amplitude difference is -31.18 dB.

—Press **Next Peak**

The "Ref" of the marker is placed at the fundamental wave while the

“Delta” is at the third harmonic. The measured value would be: the frequency offset is 200 MHz and the amplitude difference is -40.45 dB.

3. Measurement result

The fundamental wave and harmonics are shown in the figure below.

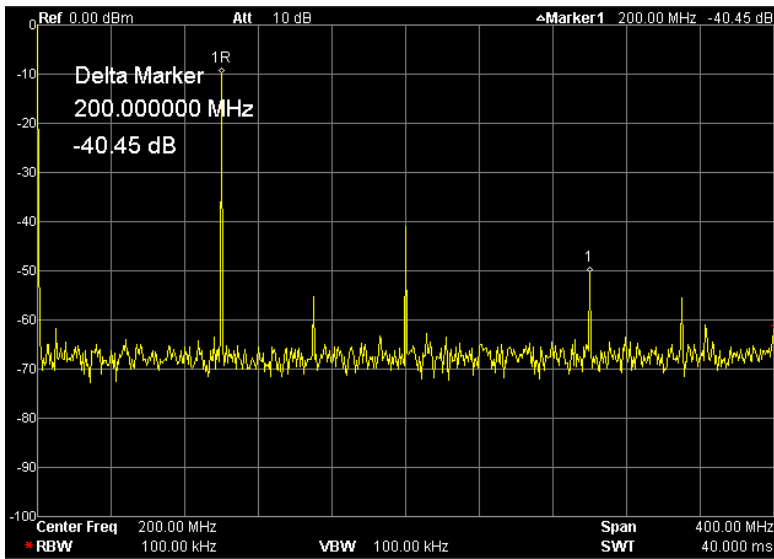

Figure 3-12 Use marker to measure harmonics

Method 2: (Use Harmonic Distortion function to measure)

Procedures:

1. Device attachment

Connect the output terminal of the generator to the **RF INPUT 50Ω** terminal on the front panel of the analyzer.

2. Use Harmonic Distortion function to measure

(1) Reset the analyzer

—Press **Preset**

(2) Set the parameters

—Press **FREQ**

—Press **Center Freq** and enter 100 MHz.

—Press **Meas**

—Press **Meas Fctn** and enter the lower menu.

—Page down

—Press **Harmo Dist**

(3) Modify the harmonic distortion settings

—Press **Meas Setup**

—Press **NO.of Harmo** and enter 3.

3. Measurement result

The measurement results shown in the lower window are:

Fundamental wave: 100 MHz, -9.90 dBm

Second harmonic: 200 MHz, -41.76 dBm

Third harmonic: 300 MHz, -50.98 dBm

Total harmonic distortion (THD): 2.72%

See figure below.

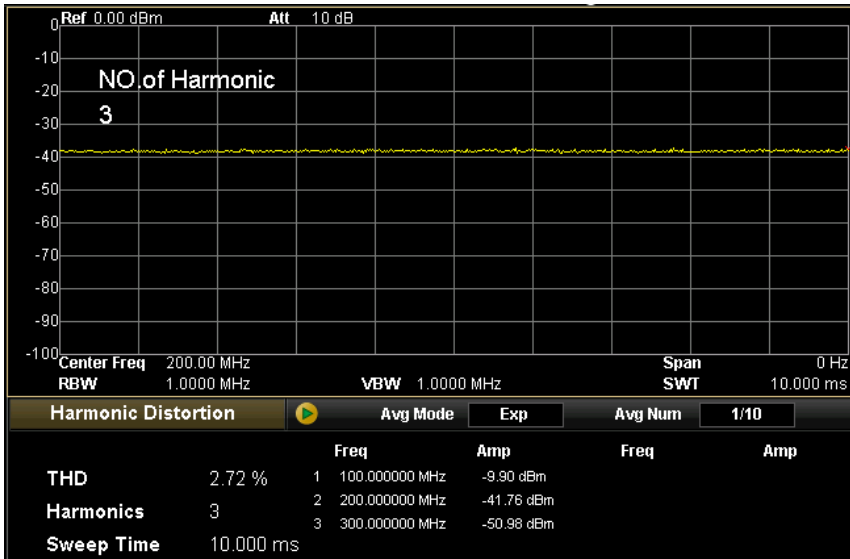

Figure 3-13 Harmonic Distortion measurement result

Measuring the TOI Distortion

In the example below, we use generator 1 (such as RIGOL DG3101A) to output a sine signal with 100 MHz and -10 dBm and generator 2 (such as RIGOL DG3121A) to output a sine signal with 100.2 MHz and -10 dBm as the signal under measure.

Method 1: (Use marker function to measure)

Procedures:

1. Device attachment

Connect the output terminals of generators 1 & 2 to the **RF INPUT 50Ω** terminal on the front panel of the analyzer through a power combiner.

2. Measure frequency and amplitude

(1) Reset the analyzer

—Press **Preset**

(2) Set the parameters

—Press **FREQ**

—Press **Center Freq** and enter 100 MHz.

—Press **SPAN**

—Press **Span** and enter 1 MHz.

(3) Use marker function to measure

—Press **Peak**

Execute the peak searching and activate a marker.

—Press **Marker**

—Press **Delta**

—Press **Peak**

—Press **Next Peak**

Read the value measured by the marker.

3. Measurement result

The result displays in the upper right corner of the screen, see figure below.

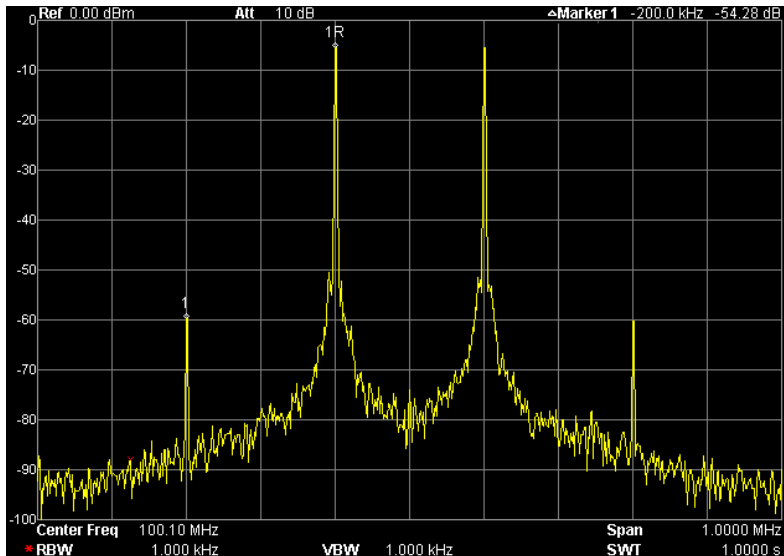

Figure 3-14 Use marker function to measure TOI distortion

Method 2: (Use TOI function to measure)

Procedures:

1. Device attachment

Connect the output terminals of generators 1&2 to the **RF INPUT 50Ω** terminal on the front panel of the analyzer through a power combiner.

2. TOI function to measure

- (1) Reset the analyzer
 - Press **Preset**
- (2) Set the parameters
 - Press **FREQ**
 - Press **Center Freq** and enter 100 MHz.
 - Press **SPAN**
 - Press **Span** and enter 1 MHz.
 - Press **Meas**
 - Press **Meas Fctn** and enter the lower menu.
 - Page down
 - Press **TOI**
- (3) Modify the TOI settings

- Press **Meas Setup**
- Press **TOI Span** and enter 2 MHz.

3. Measurement result

The measurement results shown in the lower window are:

	Freq	dBm	dBc	Intercept
Base Lower	100 MHz	-5.7 dBm	0	---
Base Upper	100.2 MHz	-5.65 dBm	0.05	---
3rd Order Lower	99.8 MHz	-60.16 dBm	-54.46	21.53
3rd Order Upper	100.4 MHz	-60.93 dBm	-55.23	21.99

See figure below.

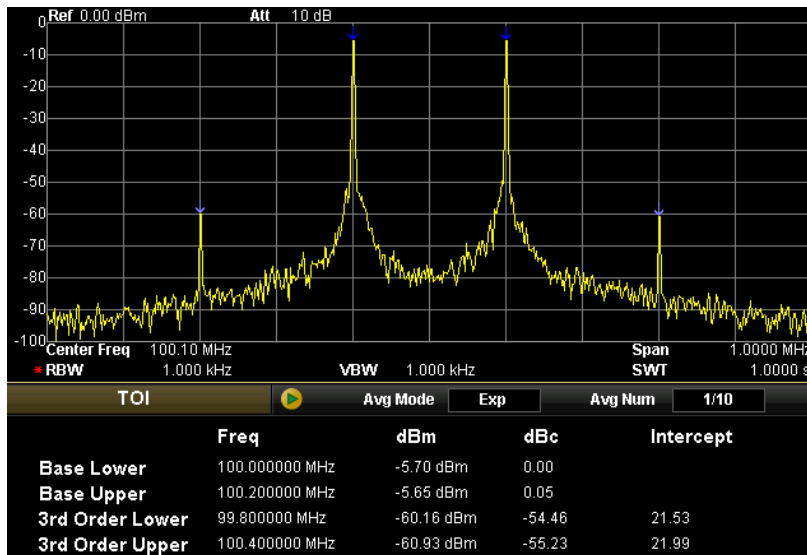

Figure 3-15 Use TOI function to measure TOI distortion

Pass/Fail Measurement

In the example below, we use a generator (such as RIGOL DG3101A) to output a sine signal with 100 MHz and -10 dBm as the signal under measure.

Procedures:

1. Device attachment

Connect the output terminal of the generator to the **RF INPUT 50Ω** terminal on the front panel of the analyzer.

2. Measure the signal over the Pass/Fail function

- (1) Reset the analyzer
 - Press **Preset**
- (2) Set the parameters
 - Press **FREQ**
 - Press **Center Freq** and enter 100 MHz.
 - Press **SPAN**
 - Press **Span** and enter 10 MHz.
 - Press **Meas**
 - Press **Meas Fctn**
 - Press the page down key
 - Press **Pass/Fail**
- (3) Edit the limit line
 - Press **Meas Setup**
 - Press **Edit**
 - Press **Point** and enter 1.
 - Press **X Axis** and enter 95 MHz.
 - Press **Amplitude** and enter -55 dBm.
 - Press **Connected** and select NO.
 - Add the points listed in the table below.

No.	Upper	Ampl	Connected	No.	Lower	Ampl	Connected
1	95 MHz	-55 dBm	No	1	95 MHz	-75 dBm	No
2	99 MHz	-55 dBm	Yes	2	105 MHz	-75 dBm	Yes
3	99.5 MHz	-5 dBm	Yes				
4	100.5 MHz	-5 dBm	Yes				
5	101 MHz	-55 dBm	Yes				
6	105 MHz	-55 dBm	Yes				

- (4) Turn on the test
 - Press **Meas Setup**
 - Press **Limit** and select Upper.
 - Press **Test** and select On.
 - Press **Limit** and select Lower.
 - Press **Test** and select On.

3. Measurement result

The measurement results shown in the lower window are:

P: Pass

278: pass number

100%: P/F Ratio

See figure below.

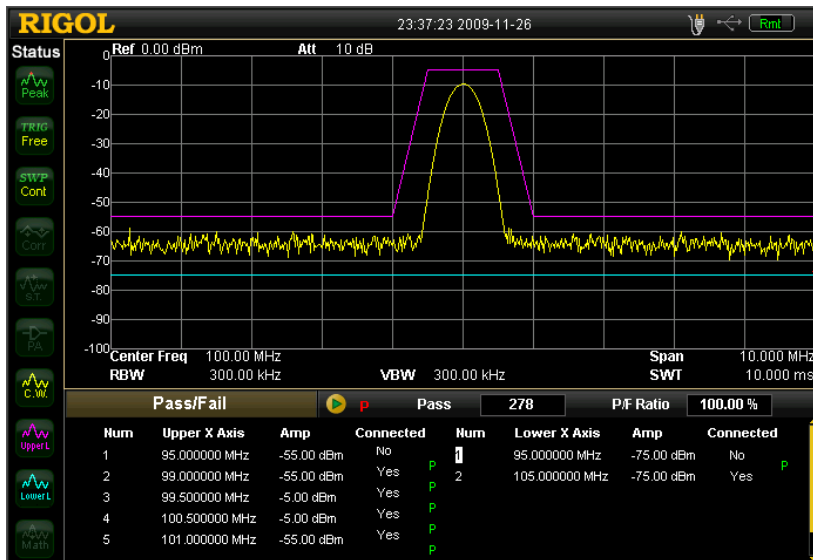

Figure 3-16 Pass/Fail testing

Amplitude Correction

Edit an amplitude-frequency curve to correct the current measured curve.

Procedures:

1. Enter amplitude correction

- Press **AMPT**
- Page down
- Press **Corrections** and enter the lower menu.

2. Select a curve

- Press **Select**
- Press **Antenna**

3. Open amplitude correction

- Press **Correction** to enable or disable the amplitude correction.
- Press **Corr Table** to turn on or off the correction table.

4. Edit the correction points

- Press **Edit** and enter the lower menu.
- Press **Frequency** and enter 100 MHz.
- Press **Amplitude** and enter 10 dB.

A correction point with 100 MHz and 10 dB is added.

- Press **Point** and enter 2.
- Press **Frequency** and enter 200 MHz.
- Press **Amplitude** and enter 20 dB.

Another correction point with 200 MHz and 20 dB is added.

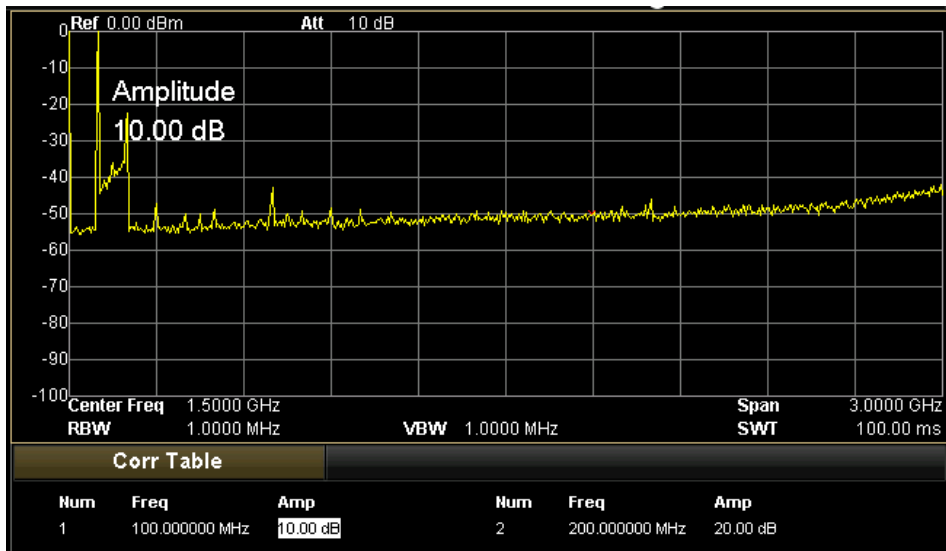

Figure 3-17 Amplitude correction

Tracking Generator (DSA1030A-TG)

The frequency response of a filter can be measured by using the tracking generator of the analyzer. In the example below, we use a Low Pass Filter of 300 MHz as the filter under measure.

Procedures:

1. Device attachment

Connect the filter under measure to the **RF INPUT 50Ω** and **GEN OUTPUT 50Ω** terminal of the analyzer.

2. Measure the frequency response of a filter

(1) Reset the analyzer

— Press **Preset**

(2) Set the parameters

— Press **FREQ**

— Press **Stop Freq** and enter 1GHz.

— Press **Source**

— Press **TG** and select “On”.

(3) Normalization

Connect the **RF INPUT 50Ω** terminal to the **GEN OUTPUT 50Ω** terminal.

— Press **Normalize** and enter the lower menu.

— Press **Stor Ref**

Save the reference curve and eliminate the influence of the frequency response from the analyzer itself.

Connect the filter under measure to the **RF INPUT 50Ω** and **GEN OUTPUT 50Ω** terminal of the analyzer.

— Press **Normalize** and turn on the normalization.

3. Measurement result

The frequency response of the filter under measure is shown in the figure below.

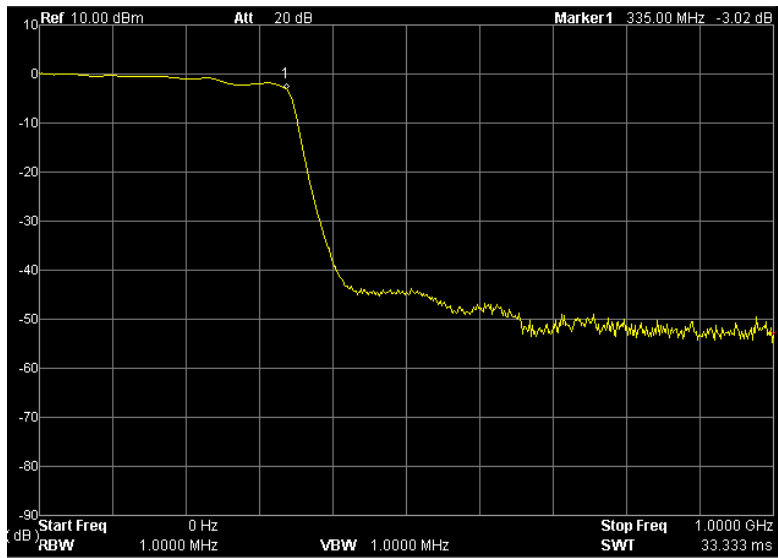

Figure 3-18 The frequency response of a filter

Chapter 4 Remote Control

Two means can be used to control the analyzer remotely.

User-defined programming

Users can program and control the analyzer by using the SCPI (Standard Commands for Programmable Instruments) commands. For more information about the commands and programming, refer to *DSA1000A Series Programming Guide*.

Use PC software to send SCPI commands

Users can use the PC software **Ultra Sigma** of **RIGOL** to send SCPI commands to control the spectrum analyzer remotely.

This spectrum analyzer can communicate with PC through USB, LAN and GPIB (with the USB-GPIB interface converter provided by **RIGOL**) instrument buses. This chapter will give a detailed introduction of how to use Ultra Sigma to control the spectrum analyzer remotely through various interfaces. For the Ultra Sigma software and its operation methods, please contact **RIGOL** salesmen or technical support.

Subjects in this chapter:

- Remote Control via USB
- Remote Control via LAN
- Remote Control via GPIB

Remote Control via USB

1. Connect the device

Connect the analyzer with your PC as shown in Figure 1-12 .

2. Install the USB drive

As the analyzer is a USBTMC device, after you connect the spectrum analyzer to the PC and turn both on (the spectrum analyzer is automatically configured to USB interface), the “Found New Hardware Wizard” dialog box is displayed on the PC. Please install the “USB Test and Measurement Device (IVI)” driver following the directions in the wizard.

3. Search for device resources

Start-up Ultra Sigma and the software searches for the analyzer resources connected with PC automatically. You can also click **USB-TMC** to search for the resources manually.

4. View the resources

The resources found are shown under the “RIGOL Online Resource” directory together with the instrument model and USB interface information, as shown in the figure below.



Figure 4-1 View the resource

5. Communication test

Right click the resource name "DSA1030A (USB0::0x0400::0x09C4::DSA1A124400148::INSTR)" and select "SCPI Panel Control" to turn on the remote command control panel (as shown in the figure below) through which you can send commands and read data.

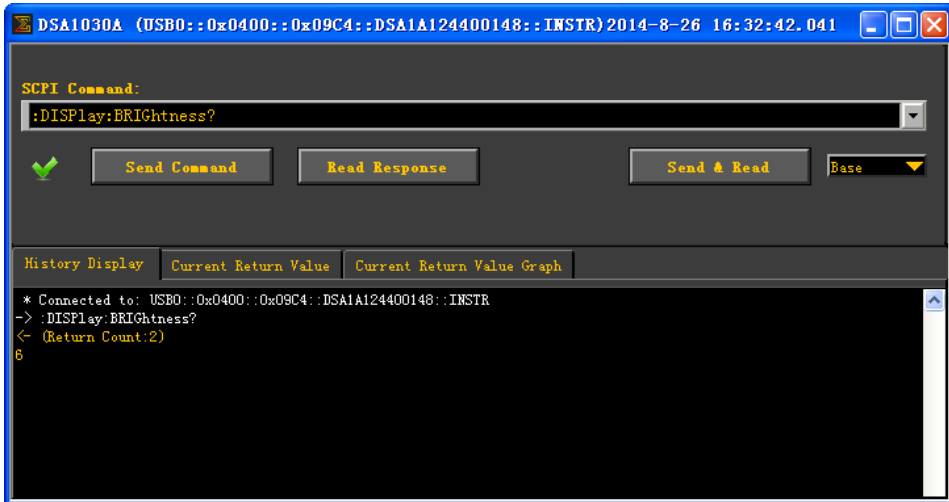

Figure 4-2 Write and read commands via USB

Remote Control via LAN

1. Connect the device

Connect the spectrum analyzer to your local network as shown in Figure 1-13.

2. Configure network parameters

Select LAN interface according to the description in "I/O Settings → LAN".

3. Search for device resources

Start-up Ultra Sigma and click **LAN**; then click **Search** in the pop-up window. The software searches for the analyzer resources connected to the LAN. The instrument resources found will be displayed in the resource box at the right of the window. Select your desired resource and click

OK, as shown in the figures below.



(a)

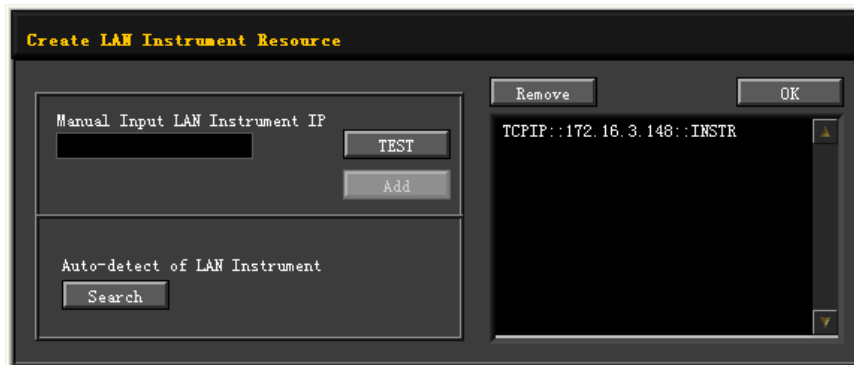

(b)

Figure 4-3 Search LAN resources

4. View the resources

The resources found are shown under the “RIGOL Online Resource” directory as shown in the figure below.



Figure 4-4 View the resource

5. Communication test

Right click the resource name “DSA1030A (TCPIP::172.16.3.148::INSTR)” to select “SCPI Panel Control” to turn on the remote command control panel (as shown in the figure below) through which you can send commands and read data.

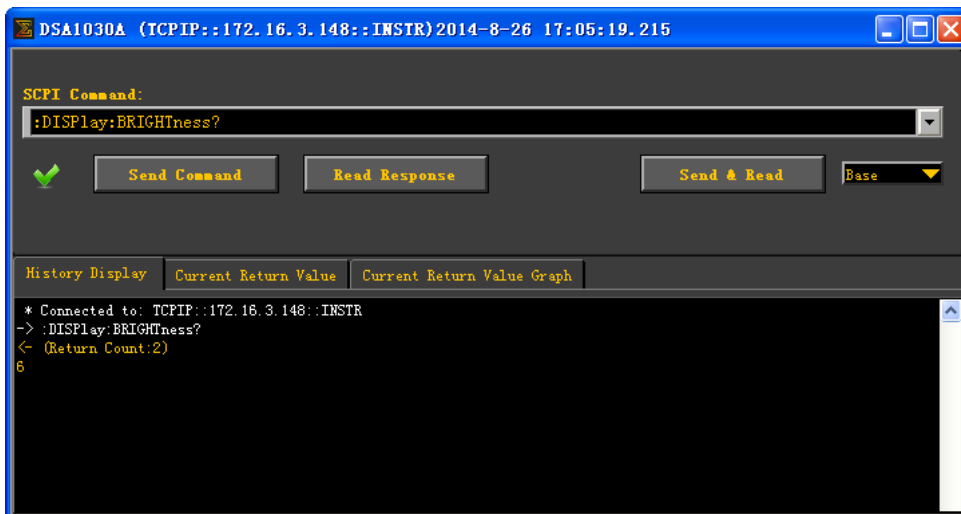

Figure 4-5 Write and read commands via LAN

6. Load LXI webpage

The analyzer confirms to LXI Core 2011 Device standards. You can load LXI webpage conveniently by right-clicking the resource name and selecting “LXI-Web”. From the webpage, you can see some important information about the analyzer such as the model, manufacturer, serial number, MAC address, IP address and etc. As shown in the figure below.

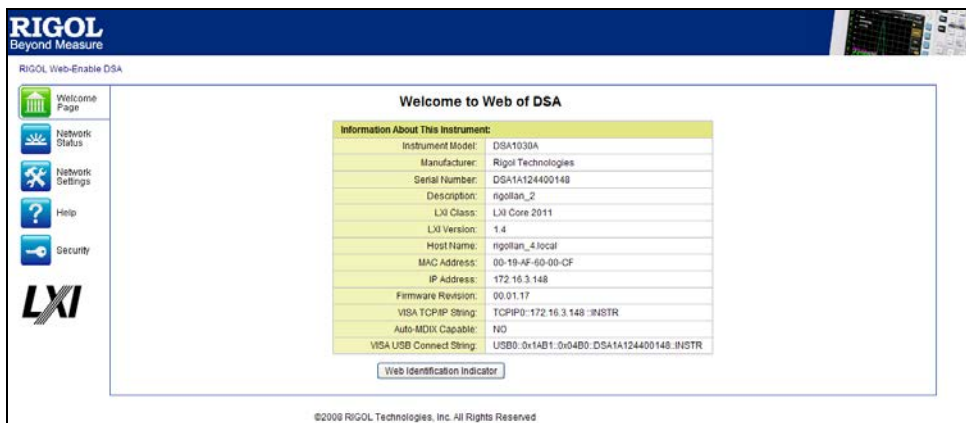

Figure 4-6 LXI Webpage

Note: If you want to view or modify the network settings of the instrument, click



and input the initial password “RIGOL” (uppercase letters are required) in the popup window (by default, the user name is empty). Besides, you



can click to modify the password.

Remote Control via GPIB

1. Connect the device

Connect the analyzer to the PC (configured with GPIB card) using **RIGOL** USB-GPIB interface converter (option) by referring to “GPIB extended connection” in Figure 1-4 .

2. Install the driver of the GPIB card

Install the driver of the GPIB card which has been correctly connected to the PC.

3. Set the GPIB address

Set the GPIB address of the spectrum analyzer by referring to “I/O Settings → GPIB”.

4. Search for device resources

Start-up Ultra Sigma and click **GPIB** to open the following interface.

Then, click “Search” and the software searches for the GPIB analyzer resources to PC automatically. The descriptors of the instrument resources found are displayed at the right of the interface.



Figure 4-7 GPIB Setting

If resources cannot be found automatically:

- Select the GPIB card address of the PC from the “GPIB::” dropdown box and select the GPIB address set in the spectrum analyzer from the “::INSTR” dropdown box.

- Click “Test” to check whether the GPIB communication works normally; if not, please follow the corresponding prompt messages to solve the problem.

5. View the resources

Click  to return to the main interface of Ultra Sigma. The GPIB instrument resources found are shown under the “RIGOL Online Resource” directory.



Figure 4-8 View the GPIB resource

6. Communication test

Right-click the resource name "DSA1030A (GPIB0::1::INSTR)" to select "SCPI Panel Control" to turn on the remote command control panel through which you can send commands and read data as shown in the figure below.



Figure 4-9 Write and read commands via GPIB

Chapter 5 Troubleshooting

Troubleshooting

To help you solve commonly encountered problems we have listed some typical issues with their respective solutions. If the problems persist contact **RIGOL** and prepare your device information (**System** → **Information** → **System Info**).

1. The screen still dark (no display) after power on:

- (1) Check if the fan is running:
 - If running, the connection of the internal screen cable may be loose.
 - If not, the instrument has failed to power up, please refer to step (2) or (3).
- (2) If the battery (China only) is used for power supply:
 - Check whether the battery is in good condition and whether it is correctly installed.
 - Check whether the battery status indicator  at the front panel goes on; if not, the battery contains no electricity and please charge the battery.
- (3) If AC power is used for power supply:
 - Check whether the power supply is correctly connected or the power switch is turned on.
 - Check whether the power fuse is burned. If a new fuse needs to be installed, please select one with these specifications: 250V AC, T2A; 5 mm×20 mm.

2. Unresponsive keys or wrong response

- (1) Press all the keys on the front panel to make sure that each of them is normal after power on.
- (2) Press **System** → **Self-Test** → **Key Test** to see if all keys are working properly.
- (3) If a key is not working, do not disassemble the instrument by yourself and contact **RIGOL**.

3. The spectrum lines on the screen do not update for long periods:

- (1) Check if the screen is locked, if so, press Esc to unlock.
- (2) Check if the instrument is in Remote control.
- (3) Verify if all the trigger conditions have been met and if there is a valid trigger signal.
- (4) Check if the analyzer is in Single sweep.

(5) Check if the current sweep time is too long.

4. Wrong measurement results or poor precisions:

To verify the system errors and view the measurement accuracies and precision, refer to the tolerance specifications or characteristics from the *User's Guide*.

To get the characteristics listed in the *User's Guide*, please:



- (1) Check if all the peripheral equipment has been successfully connected and is working normally.
- (2) Review the signal under measure and set appropriate instrument parameters.
- (3) Make measurements under proper conditions, for example: warm-up the instrument appropriately and operate within the specified environment and temperature.
- (4) Calibrate the instrument regularly to reduce or avoid errors that can occur over time.
 - Press **System** → **Information** → **System Info** to get the last calibration time and decide if a new calibration is required. If you need a specific calibration after the stated calibration period, contact **RIGOL** for service options.
 - The analyzer provides a self-calibration function. If required, press **System** → **Calibrate** → **Self-Cal**, and the instrument will do a self-calibration once the operating temperature has changed.
 - Press **System** → **Calibrate** → **Cal Now** to do a self-calibration immediately.

5. Prompt Message:

The instrument may give common prompts, error prompts, or state prompts according to the current status to assist in proper use of the analyzer or to show warnings that some fault might happen to the instrument.

Messages

Messages fall into three types on the basis of the tips purpose: Information Message, Error Message, and Status Message. To get accurate measurements and specific working status of the analyzer, you should be familiar with these messages.

1. **Information Message:** to give a clue that the current task has finished or the analyzer has entered a specified state. The messages are always marked with an  icon and displayed on the screen for several seconds and then hidden automatically, or you can press any key to clear the display of this message. Message number: 1 - 199.
2. **Error Message:** to warn you that the current operation cannot be executed and has been ignored or paused for some reason. These messages are always marked with an  icon and displayed on the screen for several seconds and then hidden automatically, or you can press any key to clear the display of this error message.

Error Messages based on the cause of the error are divided into Command Error, Execution Error, Device Specific Error, or Query Error. Each of the errors corresponds to a specific bit pattern in the Standard Event Status Register (see IEEE 488.2,11.5.1). When you find there is an error generated in the Standard Event Status Register, send command :SYSTem:ERRor? in Remote Mode to get the information on this error and find the cause of it.

- (1) **Command Error:** indicates a command error is detected by the Parser while in Remote control (see IEEE488.2,6.1.6), possible reasons are:
 - The Parser detects a syntax error; (see IEEE488.2,7.1.2.2)
 - An unrecognized command header or a parameter that is of the wrong type for its associated header is received. (see IEEE488.2,10)Message number: -199 to -100.
- (2) **Execution Error:** indicates an execution error is detected by the Execution Control Block, possible reasons are:
 - A parameter following a header was evaluated by the device as outside of its legal input range or is otherwise inconsistent with the

device's capabilities.

- A valid program message could not be properly executed due to some device condition.

Message number: -299 to -200.

- (3) Device Specific Error: indicates a device specific error is generated when the commands cannot be correctly executed due to current settings of the hardware and software of the device.

Message number: -399 to -300 (defined in SCPI standard) and 300 to 1000.

- (4) Query Error: indicates a query error is generated when the output queue controller (see IEEE488.2,6.5.7) fails to follow the Message Exchange Control Protocol under any of the conditions below: (see IEEE488.2,6.1.10)

- When trying to read the output queue, the queue has no data or is being suspended.
- Data in the output queue has been lost.

Message number: -499 to -400.

3. Status Message: to warn you that the analyzer is now in a certain condition and should be paid attention to. The messages are always marked with an  icon and displayed on the screen until the **Esc** key has been pressed or the ***CLS** command is used. The messages are stored in corresponding status register, and can be queried by sending **:Status:** or **:SYSTEM:ERROR[:NEXT]?**.
Message number: 200 to 299.

Information Message

Number	Error Description
1	PictBridge printer connected. PictBridge printer has already been connected successfully and is waiting for initialization.
2	PictBridge printer installed successfully. PictBridge printer has already been installed successfully and is ready for printing.
3	PictBridge printer disconnected.
4	Printing task finished.
5	Printing task paused. Printing task has to be paused as an error, please solve the problem and select RESUME. For the source of error please refer to the Message List.
6	Printing task stopped. An error occurred when printing, please select "Cancel" to stop the print job.
7	Printing task canceled.
8	Printing task resumed.
10	USB Disk connected. The USB storage device has already been connected and is waiting for initialization.
11	USB Disk installed successfully.
12	USB Disk removed.
13	Start updating firmware. Updating firmware, please wait and keep the connection between the USB storage device and the analyzer. For more information about updates, please refer to the Service Manual or report the error to your distributor or to your RIGOL technical support.
14	Updating firmware completed. Updating firmware is finished, the new firmware program will be executed automatically as soon as you restart the device.
15	Saving file completed.
16	To Recover file existed.
17	Load data with old revision. Loading data from the old edition to the current, which may cause a

failure to work.

- 18 The last spell char is allowed to input.
- 19 Please select the valid file type.
- 30 LAN connected.
- 31 LAN disconnected.
- 41 Welcome to User Mode.
- 50 Please Confirm, and press twice.
- 51 The display was locked, please press Esc to unlock.
- 52 Display unlocked.
- 54 Please select the valid file.
- 55 It is not allowed to delete folder.
- 56 Fail to load file.
- 57 Local Disk is being Formatted, please wait for a moment.
- 58 Formatting is finished.
- 60 Software version is not matched, file loading is failed.
- 61 Invalid source.
- 62 Select where to load, antenna, cable, user or others.
- 63 Option is activated.
- 64 Option is deleted.
- 65 The edit frequency has been existed.
- 80 Limit lines are cleaned because of change of X Axis type.
- 81 Copy complete.
- 82 Do you want to replace the exist file?
- 83 Please select the copy.
- 84 Fail to copy , as the destination is the same as the source.
- 85 Updating the reference trace...

Error Message

Command Error

Number	Error Description
0	Everything is OK.
-100	Command error. This is a generic syntax error for devices that cannot detect more specific errors. This code indicates only that a Command Error as defined in IEEE 488.2,11.5.1.1.4 has occurred.
-101	Invalid character. A syntactic element contains a character which is invalid for that type; for example, a header containing an ampersand, SETUP&. This error might be used in place of errors -114, -121, -141, and perhaps some others.
-102	Syntax error. An unrecognized command or data type was encountered; for example, a string was received when the device does not accept strings.
-103	Invalid separator. The parser was expecting a separator and encountered an illegal character; for example, the semicolon was omitted after a program message unit, *EMC 1:CH1:VOLTS 5.
-104	Data type error. The parser recognized a data element different than one allowed; for example, numeric or string data was expected but block data was encountered.
-105	GET not allowed. A Group Execute Trigger was received within a program message (see IEEE 488.2, 7.7).
-108	Parameter not allowed. More parameters were received than expected for the header; for example, the *EMC common command only accepts one parameter, so receiving *EMC 0, 1 is not allowed.
-109	Missing parameter. Fewer parameters were received than required for the header; for example, the *EMC common command requires one parameter, so receiving *EMC is not allowed.

- 110 Command header error.**
An error was detected in the header. This error message should be used when the device cannot detect the more specific errors described for errors -111 through -119.
- 111 Header separator error.**
A character which is not a legal header separator was encountered while parsing the header; for example, no white space followed the header, thus *GMC"MACRO" is an error.
- 112 Program mnemonic too long.**
The header contains more than twelve characters (see IEEE 488.2, 7.6.1.4.1).
- 113 Undefined header.**
The header is syntactically correct, but it is undefined for this specific device; for example, *XYZ is not defined for any device.
- 114 Header suffix out of range.**
The value of a numeric suffix attached to a program mnemonic, see Syntax and Style section 6.2.5.2, making the header invalid.
- 115 Unexpected number of parameters.**
The number of parameters received does not correspond to the number of parameters expected. This is typically due to an inconsistency with the number of instruments in the selected group (see section on INSTRument:DEFine:GROup).
- 120 Numeric data error.**
This error, as well as errors -121 through -129, are generated when parsing a data element which appears to be numeric, including the non-decimal numeric types. This particular error message should be used if the device cannot detect a more specific error.
- 121 Invalid character in number.**
An invalid character for the data type being parsed was encountered; for example, an alpha in a decimal numeric or a "9" in octal data.
- 123 Exponent too large.**
The magnitude of the exponent was larger than 32000 (see IEEE 488.2, 7.7.2.4.1).
- 124 Too many digits.**
The mantissa of a decimal numeric data element contained more than 255 digits excluding leading zeros (see IEEE 488.2, 7.7.2.4.1).
- 128 Numeric data not allowed.**

- A legal numeric data element was received, but the device does not accept one in this position for the header.
- 130 Suffix error.**
This error, as well as errors -131 through -139, are generated when parsing a suffix. This particular error message should be used if the device cannot detect a more specific error.
- 131 Invalid suffix.**
The suffix does not follow the syntax described in IEEE 488.2, 7.7.3.2, or the suffix is inappropriate for this device.
- 134 Suffix too long.**
The suffix contained more than 12 characters (see IEEE 488.2, 7.7.3.4).
- 138 Suffix not allowed.**
A suffix was encountered after a numeric element which does not allow suffixes.
- 140 Character data error.**
This error, as well as errors -141 through -149, are generated when parsing a character data element. This particular error message should be used if the device cannot detect a more specific error.
- 141 Invalid character data.**
Either the character data element contains an invalid character or the particular element received is not valid for the header.
- 144 Character data too long.**
The character data element contains more than twelve characters (see IEEE 488.2, 7.7.1.4).
- 148 Character data not allowed.**
A legal character data element was encountered where prohibited by the device.
- 150 String data error.**
This error, as well as errors -151 through -159, are generated when parsing a string data element. This particular error message should be used if the device cannot detect a more specific error.
- 151 Invalid string data.**
A string data element was expected, but was invalid for some reason (see IEEE 488.2, 7.7.5.2); for example, an END message was received before the terminal quote character.
- 158 String data not allowed.**
A string data element was encountered but was not allowed by the

device at this point in parsing.

-160 Block data error.

This error, as well as errors -161 through -169, are generated when parsing a block data element. This particular error message should be used if the device cannot detect a more specific error.

-161 Invalid block data.

A block data element was expected, but was invalid for some reason (see IEEE 488.2, 7.7.6.2); for example, an END message was received before the length was satisfied.

-168 Block data not allowed.

A legal block data element was encountered but was not allowed by the device at this point in parsing.

-170 Expression error.

This error, as well as errors -171 through -179, are generated when parsing an expression data element. This particular error message should be used if the device cannot detect a more specific error.

-171 Invalid expression.

The expression data element was invalid (see IEEE 488.2, 7.7.7.2); for example, unmatched parentheses or an illegal character.

-178 Expression data not allowed.

A legal expression data was encountered but was not allowed by the device at this point in parsing.

-180 Macro error.

This error, as well as errors -181 through -189, are generated when defining a macro or executing a macro. This particular error message should be used if the device cannot detect a more specific error.

-181 Invalid outside macro definition.

Indicates that a macro parameter placeholder ($\$<number>$) was encountered outside of a macro definition.

-183 Invalid inside macro definition.

Indicates that the program message unit sequence, sent with a *DDT or *DMC command, is syntactically invalid (see IEEE 488.2, 10.7.6.3).

-184 Macro parameter error.

Indicates that a command inside the macro definition had the wrong number or type of parameters.

Execution Error

Number	Error Description
--------	-------------------

-200	Execution error. This is the generic syntax error for devices that cannot detect more specific errors. This code indicates only that an Execution Error as defined in IEEE 488.2, 11.5.1.1.5 has occurred.
-201	Invalid while in local. Indicates that a command is not executable while the device is in local due to a hard local control (see IEEE 488.2, 5.6.1.5);The system would be changed to remote mode by selecting the right communication I/O.
-203	Command protected. Indicates that a legal password-protected program command or query could not be executed because the command was disabled.
-220	Parameter error. Indicates that a program data element related error occurred. This error message should be used when the device cannot detect the more specific errors described for errors -221 through -229.
-221	Settings conflict. Indicates that a legal program data element was parsed but could not be executed due to the current device state (see IEEE 488.2, 6.4.5.3 and 11.5.1.1.5.)
-222	Data out of range. Indicates that a legal program data element was parsed but could not be executed because the interpreted value was outside the legal range as defined by the device (see IEEE 488.2, 11.5.1.1.5.)
-223	Too much data. Indicates that a legal program data element of block, expression, or string type was received that contained more data than the device could handle due to memory or related device-specific requirements.
-224	Illegal parameter value. Used where exact value, from a list of possible, was expected.
-225	Out of memory. The device has insufficient memory to perform the requested operation.
-233	Invalid version. Indicates that a legal program data element was parsed but could not

be executed because the version of the data is incorrect for the device. This particular error should be used when file or block data formats are recognized by the instrument but cannot be executed for reasons of version incompatibility. For example, an unsupported file version, an unsupported instrument version.

-240 Hardware error.

Indicates that a legal program command or query could not be executed because of a hardware problem in the device. This error message should be used when the device cannot detect the more specific errors described for errors -241.

-241 Hardware missing.

Indicates that a legal program command or query could not be executed because the option was not installed.

-250 Mass storage error.

Indicates that a mass storage error occurred. This error message should be used when the device cannot detect the more specific errors described for errors - 251 through -258.

-251 Missing mass storage.

Indicates that a legal program command or query could not be executed because an option mass storage with enough density was not installed.

-252 Missing media.

Indicates that a legal program command or query could not be executed because of no disk.

-253 Corrupt media.

Indicates that a legal program command or query could not be executed because of a bad disk or wrong disk formatting.

-254 Media full.

Indicates that a legal program command or query could not be executed because there is no room on the disk.

-256 File name not found.

Indicates that a legal program command or query could not be executed because an attempt was made to read or copy a nonexistent file.

-257 File name error.

Indicates that a legal program command or query could not be executed because an attempt was made to copy to a duplicate file

name.

-258 Media protected.

Indicates that a legal program command or query could not be executed because the write-protect tab on USB storage device was present.

Device Specific Error

Number	Error Description
--------	-------------------

-300	Device-specific error.
-------------	-------------------------------

This is the generic device-dependent error for devices that cannot detect more specific errors. This code indicates only that a Device-Dependent Error as defined in IEEE 488.2, 11.5.1.1.6 has occurred. Please report the error to your **RIGOL** sales or technical support team.

-310	System error.
-------------	----------------------

Indicates that some error, termed "system error" by the device, has occurred. Please report the error to your **RIGOL** sales or technical support team.

-311	Memory error.
-------------	----------------------

Indicates that local C disc is not formatted or an error occurred when self-checking. If restarting the device is still of no effect, please report the error to your **RIGOL** sales or technical support team.

-313	Calibration memory lost.
-------------	---------------------------------

Indicates that the data before delivery or last valid calibration data has been lost. Please report the error to your **RIGOL** sales or technical support team.

-314	Save/recall memory lost.
-------------	---------------------------------

Indicates that the nonvolatile data saved by the *SAV? command has been lost.

-315	Configuration memory lost.
-------------	-----------------------------------

Indicates that nonvolatile configuration data saved by the device has been lost.

-321	Out of memory.
-------------	-----------------------

An internal operation needed more memory than was available. Please report the error to your **RIGOL** sales or technical support team.

-330	Self-test failed.
-------------	--------------------------

Failure to self-test, for more information please refer to the result of the Self-test.

-340	Calibration failed.
-------------	----------------------------

Failure to calibrate. Please report the error to your **RIGOL** sales or technical support team.

-350	Queue overflow.
-------------	------------------------

A specific code entered into the queue in lieu of the code that caused the error. This code indicates that there is no room in the queue and an error occurred but was not recorded.

-360 Communication error.

-365 Time out error.

Time out when communicating with USB-GPIB Switching Module, please restart the module.

300 Print paper error.

Failure to print. Please check whether the printer paper is available and in the correct position.

301 Print ink error.

Indicates that an error occurred when printing. Please check the quantity of ink or confirm whether the ink is installed correctly.

302 Print hardware error.

Indicates that a hardware error has occurred. Please check it.

303 Print file type error.

Failure to print owing to wrong print file type.

304 Unknown print error.

310 Updating error with wrong image file.

An error occurred when updating firmware owing to a wrong format of the image file or the file has already been damaged.

311 Updating error with wrong revision.

An error occurred when updating firmware because of a revision incompatibility.

312 Updating error with failing to write flash.

An error occurred when updating firmware owing to a failure to write to the flash.

320 Invalid file path.

The file path received may not exist or an illegal path format was received.

321 Invalid input string.

An illegal string has been received.

322 File name too long.

The file name is too long to be accepted. The length should not exceed 255 characters.

323 USB Disk failed to install.

The USB storage device can not be correctly installed, please examine it

for possible damage. Any question, please contact your distributor or **RIGOL** technical support.

324 File name existed.

The file name received already exists, please re-input.

325 Input empty.

The input is empty, please input a legal string before saving.

326 Fail to save file.

327 Other language except English not supported.

Any other languages are disabled except for English.

328 File operation failed.

329 No space to save file.

The document or file can not be created or saved owing to no space available.

330 Invalid option No.

The length of option No. must be less than 4 characters.

331 Invalid license key.

The length of license key must be less than 20 characters.

333 Invalid installation, please insert USB disk again.

340 DHCP renew failed.

Failed to configure IP address with DHCP server. Please try manual IP.

341 IP conflict.

The IP address received is in conflict with another computer on the network. Please try another IP address.

342 Invalid IP.

The IP address received is invalid.

350 Can't auto-couple sweep time in zero span.

Sweep time can not be coupled automatically in zero span except for manually.

351 Zero span unavailable at power measurement mode.

354 Pre-amplifier disable.

Please adjust the settings of reference level and attenuator as well as maximum mixing level.

355 Scale/div invalid in linear scale mode.

356 Invalid function in zero span.

In zero span, the following operations cannot be executed: Signal Track On, Channel Forward, Channel Reverse, Span Zoom In, Span Zoom Out, Peak->CF, Mkr->CF, Mkr->Step, Mkr->Start, Mkr->Stop, Mkr

Delta->CF, Mkr Delta->Span, setting the Mark readout as FREQ or PERIOD.

357 Invalid function in non-zero span.

Neither Video trigger nor the marker readout in $1/\Delta$ Time is effective in non-zero span.

358 Invalid mark readout.

When the marker is in Delta Pair mode, the marker readout in $1/\Delta$ Time is of no effect; and when the marker is in normal mode, Mkr Δ ->CF and Mkr Δ ->Span are of no effect.

359 Invalid function when trace is not enabled.

To point a marker to a trace is not available when the correct trace function is not enabled.

360 User preset failed.

The User preset has failed because the edition of the saved status data is incorrect or has been damaged. In this situation, the system will execute Factory settings as the defaults.

400 Input signal power out of range.

Indicate that the input signal power is out of range, if this state continues for a long time, some damage may occur to the device. Please reduce the input power.

401 1st LO unlock.

The first LO unlock. Please report the error to your **RIGOL** sales or technical support.

402 2nd LO unlock.

The second LO unlock. Please report the error to your **RIGOL** sales or technical support.

403 Track LO unlock.

Track LO unlock. Please report the error to your **RIGOL** sales or technical support.

410 Probe power short-circuit.

Please check the Probe power short-circuit as well as its connection state.

412 Overrange occurs in DA by a volume adjustment in FM.

420 Option not installed.

The desired operation cannot be performed because a required option is not installed. For example, pressing Source with no tracking generator installed.

- 460 No peak found.**
No signal peak was found that meets the criteria under Peak Search.
- 461 No fundamental wave found.**
Indicates that no fundamental wave greater than 50dBm is found.
- 462 No two-tune signal found.**
- 463 Invalid function as cursor is not enabled.**
The cursor can not be set to the reference level unless it is enabled.

Query Error

Number	Error Description
---------------	--------------------------

-400	Query error.
-------------	---------------------

This is the generic query error for devices that cannot detect more specific errors. This code indicates only that a Query Error as defined in IEEE 488.2, 11.5.1.1.7 and 6.3 has occurred.

-410	Query INTERRUPTED.
-------------	---------------------------

Indicates that a condition causing an INTERRUPTED Query error occurred (see IEEE 488.2, 6.3.2.3); for example, a query followed by DAB or GET before a response was completely sent.

-420	Query UNTERMINATED.
-------------	----------------------------

Indicates that a condition causing an UNTERMINATED Query error occurred (see IEEE 488.2, 6.3.2.2); for example, the device was addressed to talk and an incomplete program message was received.

-430	Query DEADLOCKED.
-------------	--------------------------

Indicates that a condition causing a DEADLOCKED Query error occurred (see IEEE 488.2, 6.3.1.7); for example, both input buffer and output buffer are full and the device cannot continue.

-440	Query UNTERMINATED after indefinite response.
-------------	--

Indicates that a query was received in the same program message after a query requesting an indefinite response was executed (see IEEE 488.2, 6.5.7.5).

Status Message

Number	Error Description
--------	-------------------

202	Auto range...
-----	---------------

203	Auto tune...
-----	--------------

204	Calibrating...
-----	----------------

205	Waiting for triggered...
-----	--------------------------

If it is not in freerun mode, the system will keep waiting until it receives the trigger signal.

252	Auto range finished.
-----	----------------------

253	Auto tune finished.
-----	---------------------

254	Self-calibration finished.
-----	----------------------------

255	Triggered.
-----	------------

Chapter 6 Specification

The technical specifications are valid under the following conditions: the instrument is within the calibration period, is stored for at least two hours at 5°C to 40°C temperature and is warmed up for 30 minutes. Unless otherwise noted, the specifications in the manual include the measurement uncertainty.

Typical Value: characteristic performance, which 80 percent of the measurement results will meet at room temperature (approximately 25°C). This data is not warranted and does not include the measurement uncertainty.

Nominal Value: the expected average performance or a designed attribute (such as the 50Ω connector). This data is not warranted and is measured at room temperature (approximately 25°C).

Measured Value: an attribute measured during the design phase which can be compared with the expected performance, such as the amplitude drift variation with time. This data is not warranted and is measured at room temperature (approximately 25°C).

Note: Unless otherwise noted, all the data in this manual are the measurement results of multiple instruments at room temperature. Besides, the specifications (except the TG specifications) in this manual are for situations when the tracking generator is turned off.

Technical Specification*

Frequency

Frequency		
Frequency Range	DSA1030A, DSA1030A-TG	9 kHz to 3 GHz
Frequency Resolution		1 Hz

Internal Reference Frequency		
Reference Frequency		10 MHz
Aging Rate		<3 ppm/year
Temperature Drift	20°C to 30°C	<3 ppm

Frequency Readout Accuracy		
Marker Frequency Resolution		span/(number of sweep points-1)
Marker Frequency Uncertainty		\pm (marker frequency readout \times reference frequency uncertainty + 1% \times span + 10% \times resolution bandwidth + marker frequency resolution)

Frequency Counter		
Resolution		1 Hz, 10 Hz, 100 Hz, 1 kHz, 10 kHz, 100 kHz
Uncertainty		\pm (marker frequency readout \times reference frequency uncertainty + counter resolution)

Note: Reference frequency uncertainty = (aging rate \times time from the last calibration till now + temperature drift).

Note*: Unless otherwise noted, the specifications listed are those when the tracking generator is turned off.

Frequency Span		
Range	DSA1030A, DSA1030A-TG	0 Hz, 100 Hz to 3 GHz
Uncertainty		$\pm \text{span}/(\text{number of sweep points}-1)$

SSB Phase Noise		
Carrier Offset	10 kHz	< -88 dBc/Hz, typical
	100 kHz	< -100 dBc/Hz, typical
	1 MHz	< -110 dBc/Hz, typical

Note: Typical $f_c = 500$ MHz, $RBW \leq 1$ kHz, sample detector, number of trace averages ≥ 50 .

Bandwidth		
Resolution Bandwidth (-3dB)		10 Hz to 1 MHz, in 1-3-10 step
Resolution Bandwidth (-6dB)		200 Hz, 9 kHz, 120 kHz, 1 MHz
RBW Accuracy		< 5%, nominal
Shape Factor (60dB:3dB)		< 5, nominal
Video Bandwidth (-3dB)		1 Hz to 3 MHz, in 1-3-10 step

Amplitude

Measurement Range		
Range		DANL to +30 dBm

Maximum Input Level		
DC Voltage		50 V
CW RF Power	attenuation ≥ 20 dB	30 dBm (1W)
Max. Damage Level		40 dBm (10W)

Note: When the input level is greater than 33 dBm, the protection switch will be on.

1dB Gain Compression		
Total Power at Input Mixer	$f_c \geq 50$ MHz, preamplifier off	> 0 dBm

Note: Mixer power level (dBm) = input power (dBm) – input attenuation (dB).

Displayed Average Noise Level (DANL)		
0 dB Attenuation, RBW=VBW=10 Hz, Sample Detector, Trace Average \geq 50, Input Impedance=50 Ω , Tracking generator is disabled		
DANL (Preamplifier Off)	100 kHz to 10 MHz	<-85 dBm - 3 x (f/1 MHz) dB, typical -125 dBm
	10 MHz to 2.5 GHz	<-127 dBm + 3 x (f/1GHz) dB, typical -130 dBm
	2.5 GHz to 3 GHz	<-115 dBm
DANL (Preamplifier On)	100 kHz to 1 MHz	<-103 dBm
	1 MHz to 10 MHz	<-103 dBm - 3 x (f/1 MHz) dB, typical -143 dBm
	10 MHz to 2.5 GHz	<-145 dBm + 3 x (f/1 GHz) dB, typical -148 dBm
	2.5 GHz to 3 GHz	<-133 dBm

Display Level		
Logarithmic Scale		1 dB to 200 dB
Linear Scale		0 to Reference Level
Number of Display Points	Normal	601
	Full Screen	751
Number of Traces		3 + Math Trace
Trace Detector		Normal, Positive-peak, Negative-peak, Sample, RMS, Voltage Average, Quasi-Peak
Trace Function		Clear Write, Max Hold, Min Hold, Average, Freeze, Blank
Scale Unit		dBm, dBmV, dB μ V, V, W

Frequency Response		
10 dB attenuation, relative to 50 MHz, 20 $^{\circ}$ C to 30 $^{\circ}$ C		
Frequency Response (Preamplifier Off)	100 kHz to 3 GHz	<0.7 dB
Frequency Response (Preamplifier On)	1 MHz to 3 GHz	<1.0 dB

Input Attenuation Switching Uncertainty		
Setting Range		0 to 50 dB, in 1 dB step
Switching Uncertainty	fc=50 MHz, relative to 10 dB, 20°C to 30°C	< (0.3 + 0.01 x attenuator setting) dB

Absolute Amplitude Uncertainty		
Uncertainty	fc=50 MHz, peak detector, preamplifier off, 10 dB attenuation, input signal = -10 dBm, 20°C to 30°C	±0.4 dB

RBW Switching Uncertainty		
Uncertainty	10 Hz to 1 MHz, relative to 1 kHz RBW	<0.1 dB

Reference Level		
Range		-100 dBm to +30 dBm, in 1 dB step
Resolution	Log Scale	0.01 dB
	Linear Scale	5 digits

Level Measurement Uncertainty		
Level Measurement Uncertainty	95% confidence level, S/N>20 dB, RBW=VBW=1 kHz, preamplifier off, 10 dB attenuation, -50 dBm<reference level<0, 10 MHz<fc<3 GHz, 20°C to 30°C	<1.0 dB, nominal

RF Input VSWR		
10 dB Attenuation		
VSWR	100 kHz to 10 MHz	<1.8, nominal
	10 MHz to 2.5 GHz	<1.5, nominal
	2.5 GHz to 3 GHz	<1.8, nominal

Intermodulation		
Second Harmonic Intercept (SHI)		+35 dBm
Third-order Intermodulation (TOI)	$f_c > 30$ MHz	+7 dBm

Spurious Response		
Image Frequency		<-60 dBc
Intermediate Frequency		<-60 dBc
Spurious Response		<-88 dBm, typical
System-related Sideband	local oscillator, A/D conversion, subharmonic of first LO, harmonic of first LO	<-60 dBc
Input Related Spurious	Mixer level: -30 dBm	<-60 dBc, typical

Sweep

Sweep Time	$100 \text{ Hz} \leq \text{Span} \leq 3 \text{ GHz}$	10 ms to 3000 s
	Zero span	20 μs to 3000 s
Sweep Time Uncertainty	Non-zero Span ($100 \text{ Hz} \leq \text{Span} \leq 3 \text{ GHz}$)	5%, nominal
	Zero Span (1 ms to 3000 s)	5%, nominal
Sweep Mode		Continuous, single

Trigger

Trigger Source		Free run, Video, External
External Trigger Level		5 V TTL level, nominal

Tracking Generator (DSA1030A-TG)

TG Output		
Frequency Range		10 MHz to 3 GHz, 9 kHz settable
Output Power		-20 dBm to 0 dBm, in 1 dB step
Output Flatness	10 MHz to 3 GHz, referenced to 50 MHz	± 3 dB

Input/Output

RF Input		
Impedance		50 Ω , nominal
Connector		N female

TG out		
Impedance		50 Ω , nominal
Connector		N female

Probe Power		
Voltage/Current		+15 V, <10% at 150 mA -12.6 V _i , <10% at 150 mA

10 MHz REF In/10 MHz REF Out/External Trigger In		
Connector		BNC female
10 MHz REF Amplitude		0 dBm to 10 dBm
Trigger Voltage		5 V TTL level, nominal

USB		
	USB Host	
Connector		A plug
Protocol		Version 2.0
	USB Device	
Connector		B plug
Protocol		Version 2.0

VGA		
Connector		VGA compatible, 15-pin mini D-SUB
Resolution		800*600 @ 60Hz

General Specification

Display		
Type		TFT LCD
Resolution		800*480
Size		8.5"
Color		65536

Printer Supported		
Protocol		PictBridge

Remote Control		
USB		USB TMC
IEC/IEEE Bus (GPIB)	with USB-GPIB interface converter (option)	IEEE 488.2
LAN		10/100 Base, RJ-45

Mass Memory		
Mass Memory		Internal memory; USB Storage Device (not supplied)
Data Storage Space (Memory Depth)	Internal Storage	1G Bytes

Power Supply		
Input Voltage Range, AC		100 V to 240 V, nominal
AC Frequency Range		45 Hz to 440 Hz
Power Consumption		Typical 35 W, <60 W with all options.
Operation Time at Battery Power Supply (China only)		About 3 hours, nominal

Temperature		
Operating Temperature Range		5°C to 40°C
Storage Temperature Range		-20°C to 70°C

Dimensions		
	(W x H x D)	399 mm x 223 mm x 159 mm (15.7 inches x 8.78 inches x 6.26 inches), approximate

Weight		
	Without battery	6.2 kg (13.7 lbs), approximate
	With battery	7.4 kg (16.3 lbs), approximate

Chapter 7 Menu Map

This chapter provides a visual representation of the front panel keys and associated menu keys. Refer to “**Front Panel Key Reference**” for key function descriptions.

Subjects in this chapter:

- AMPT
- BW
- Demod
- Detector
- Display
- FREQ
- Marker
- Marker Fctn
- Marker->
- Meas
- Meas Setup
- Peak
- Print Setup
- SPAN
- Storage
- Sweep
- System
- Source
- Trace
- Trig

AMPT

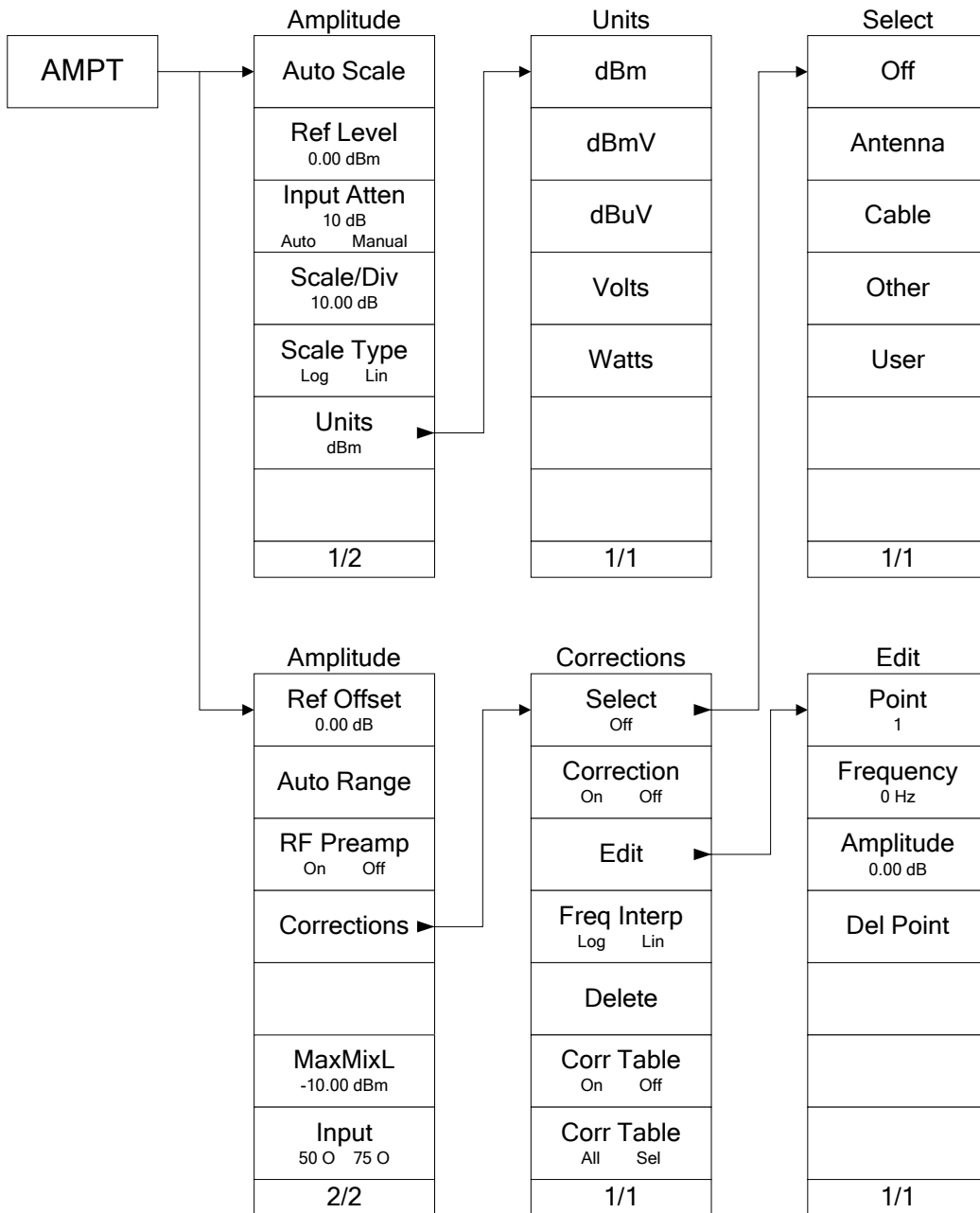

BW

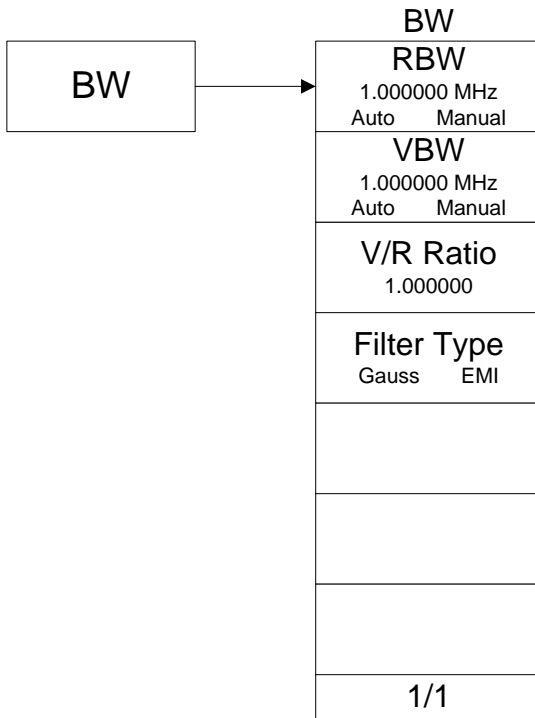

Demod

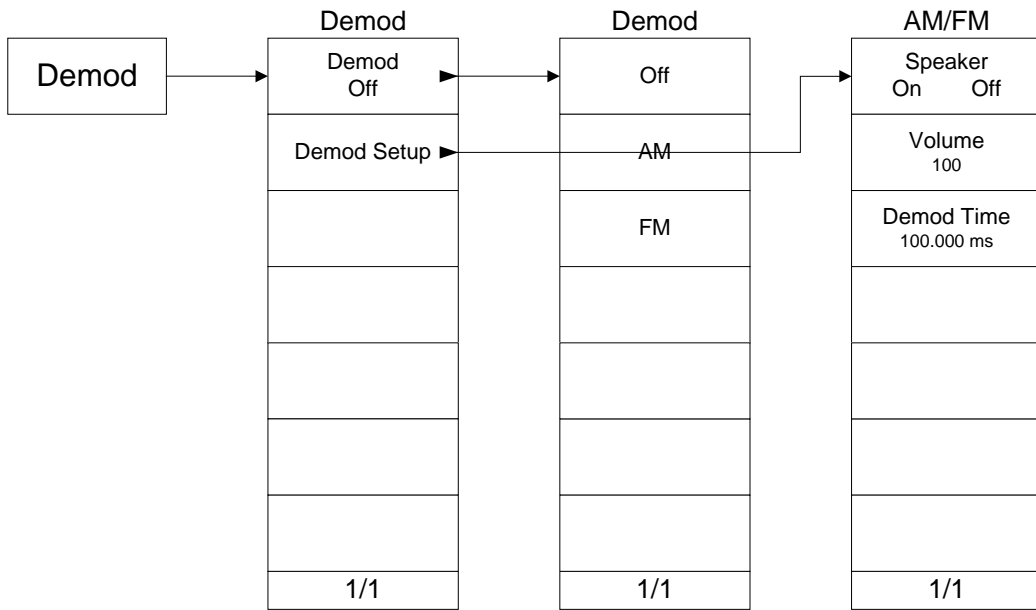

Detector

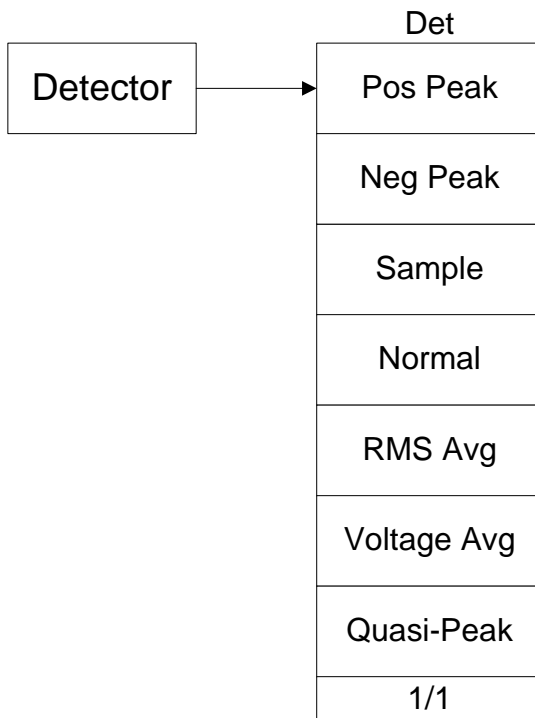

Display

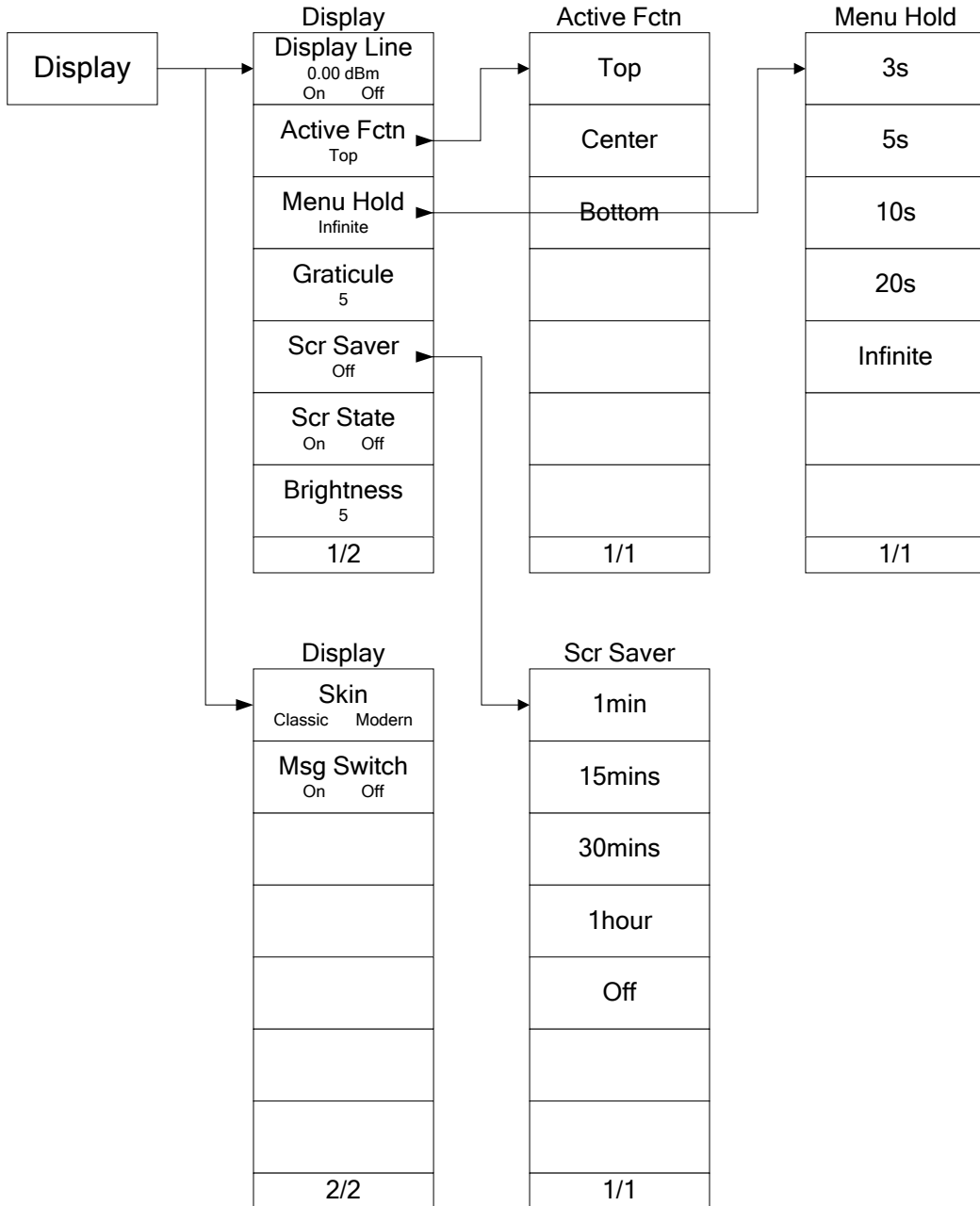

FREQ

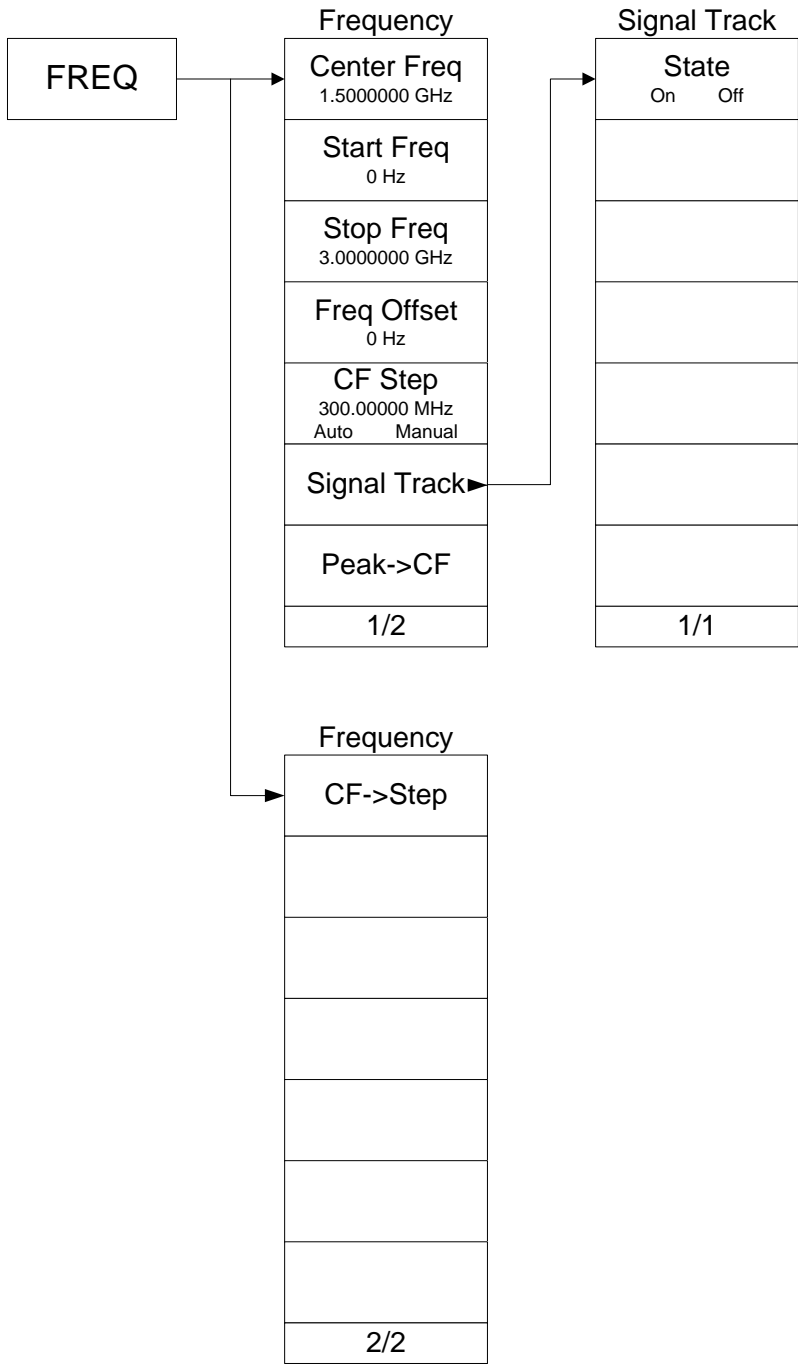

Marker

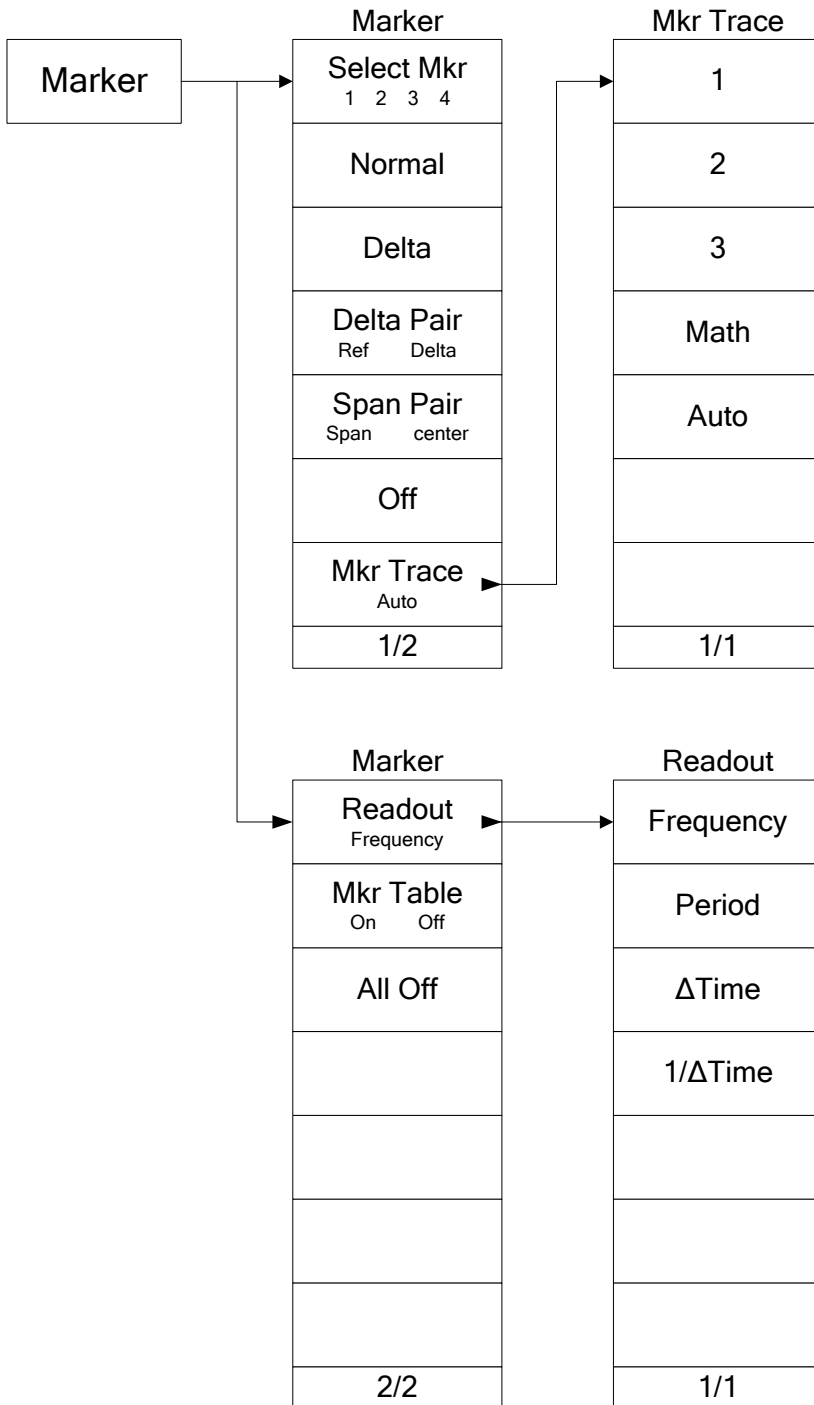

Marker Fctn

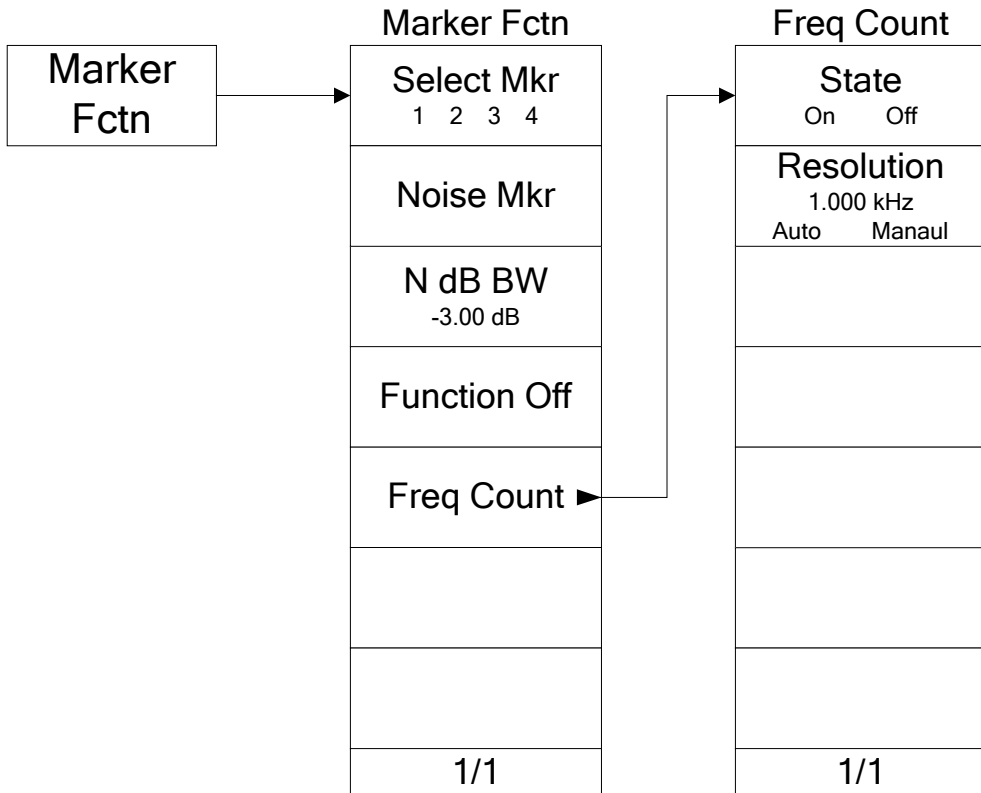

Marker->



Meas

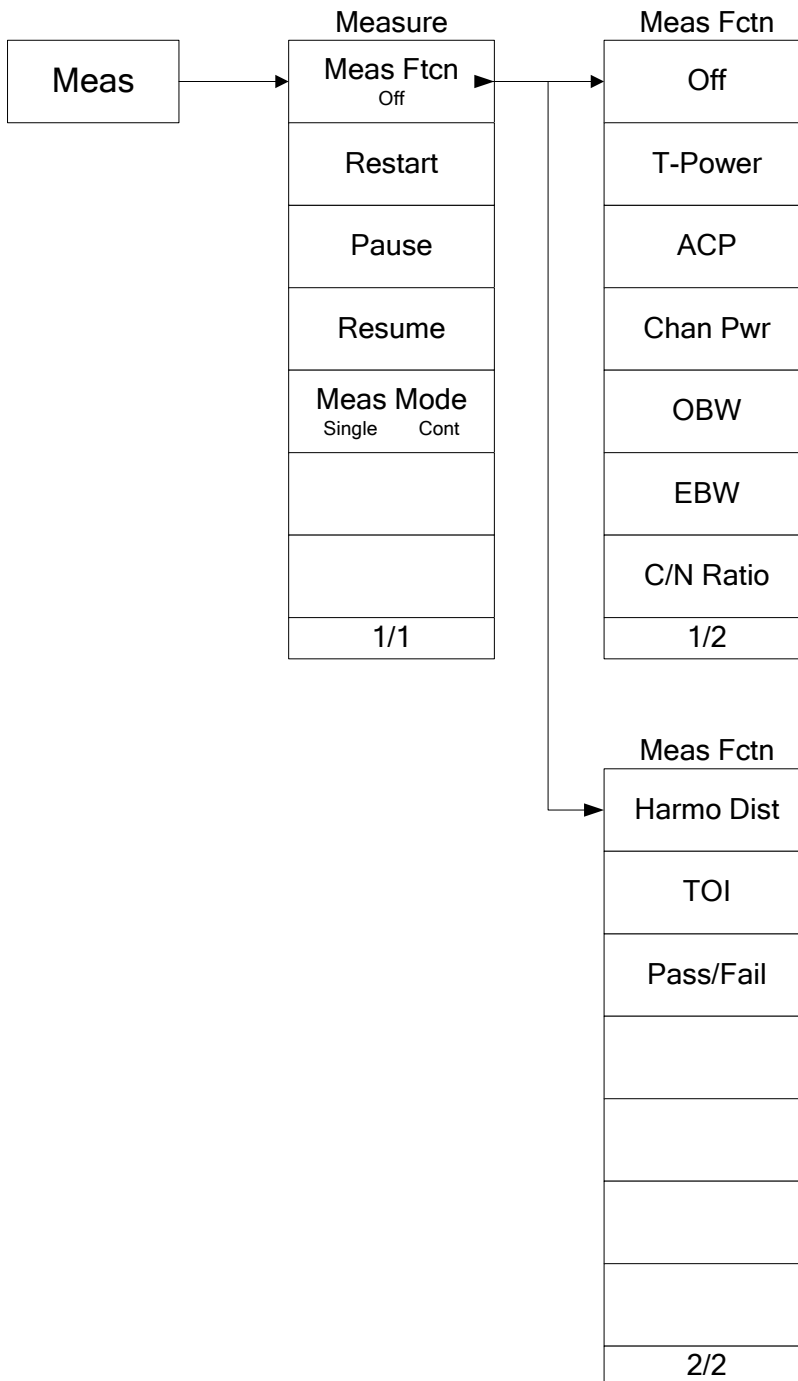

Meas Setup

T-Power

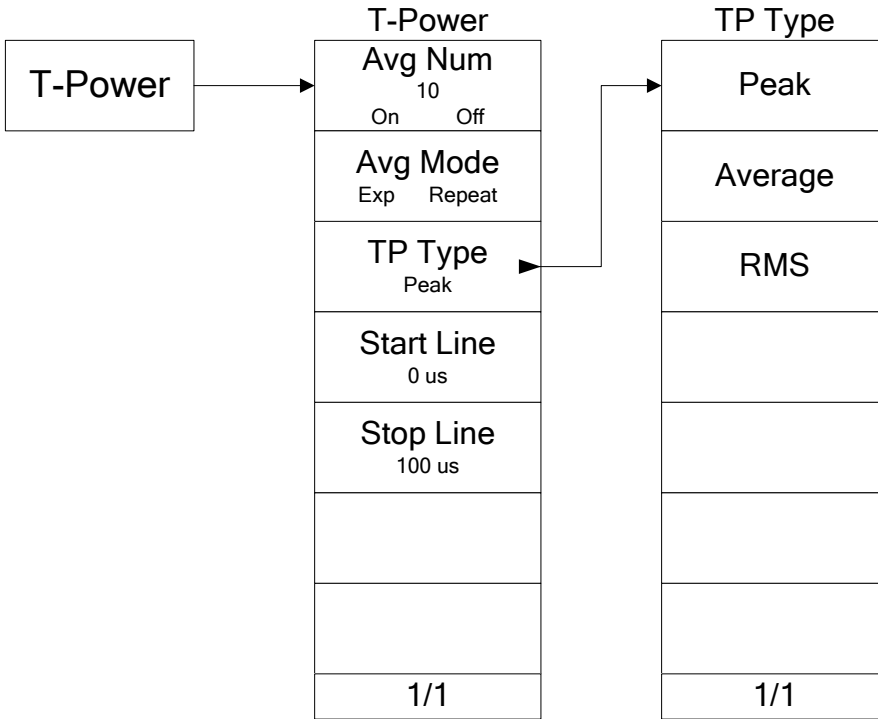

ACP

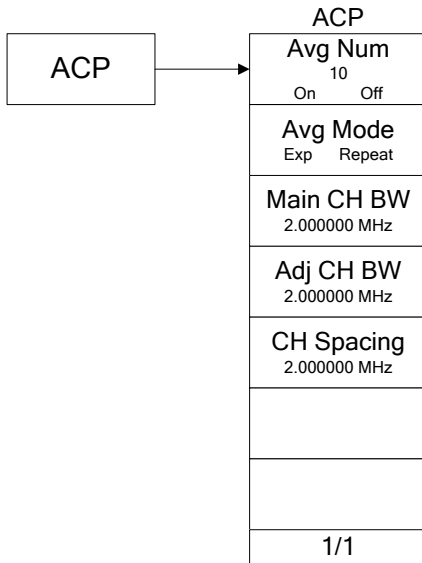

Channel Power

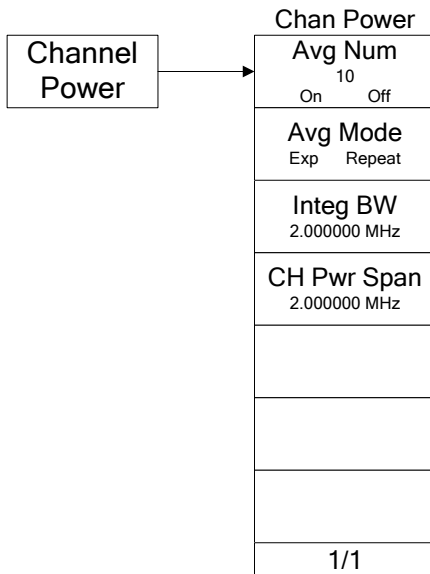

OBW

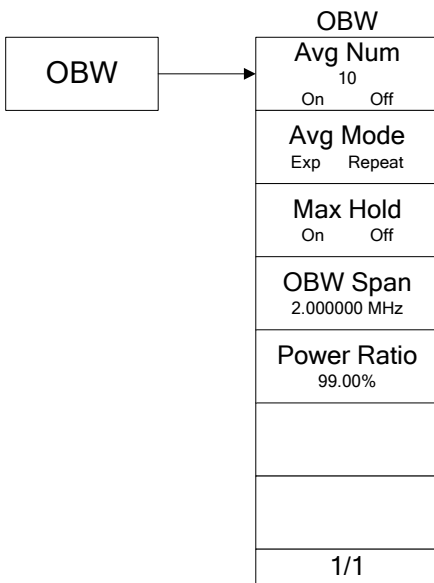

EBW

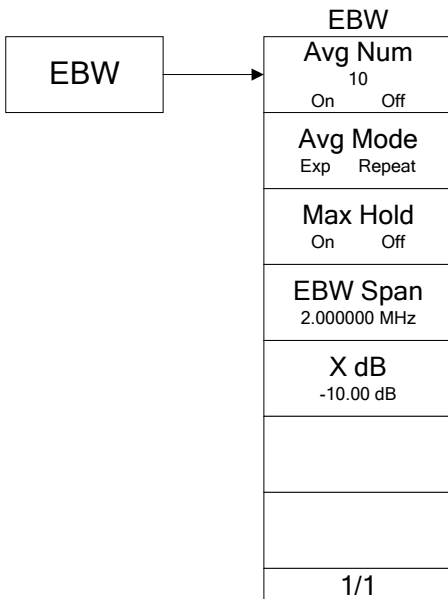

C/N Ratio

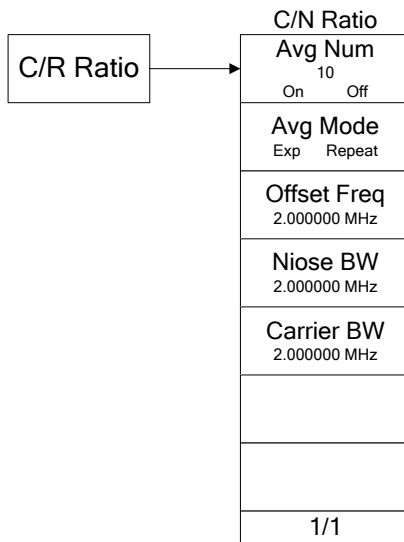

Harmonics Dist

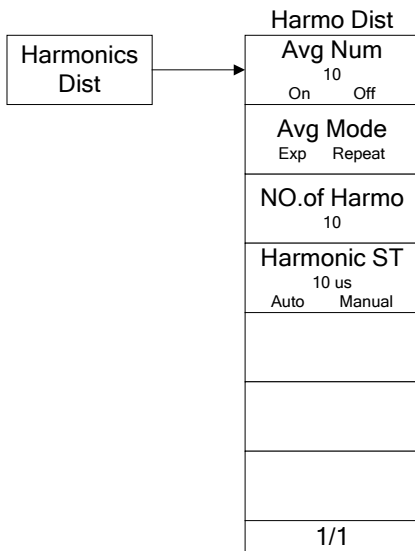

TOI

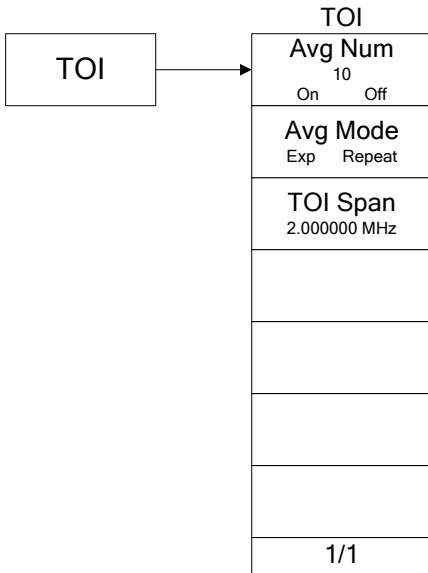

Pass/Fail

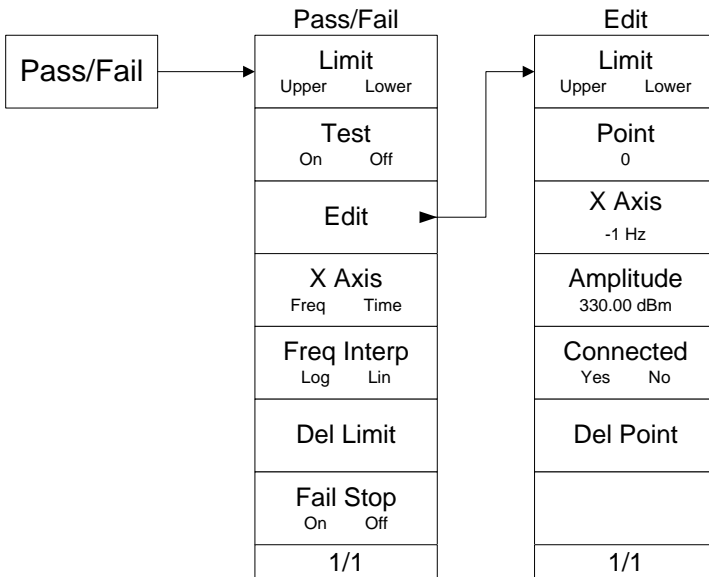

Peak

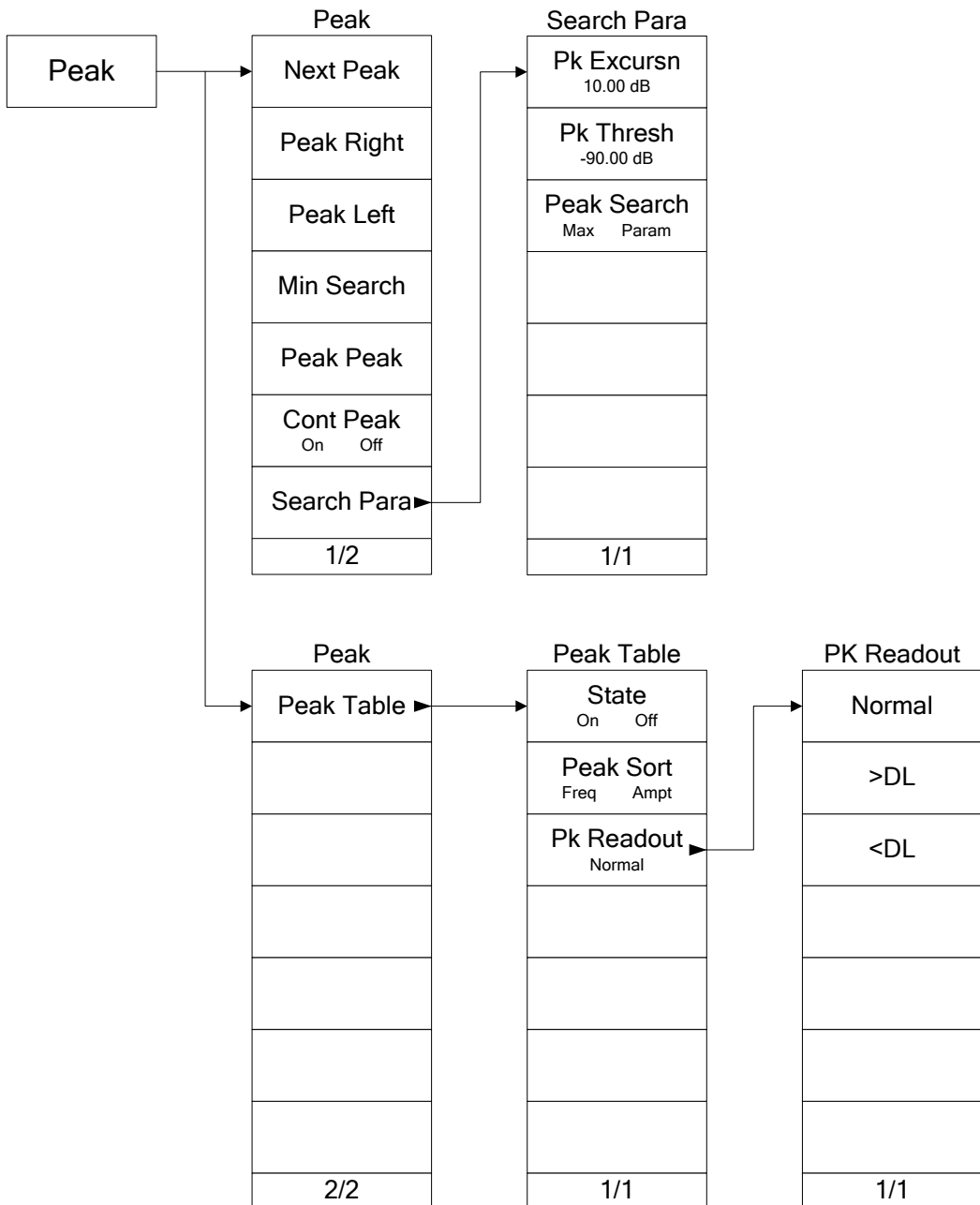

Print Setup

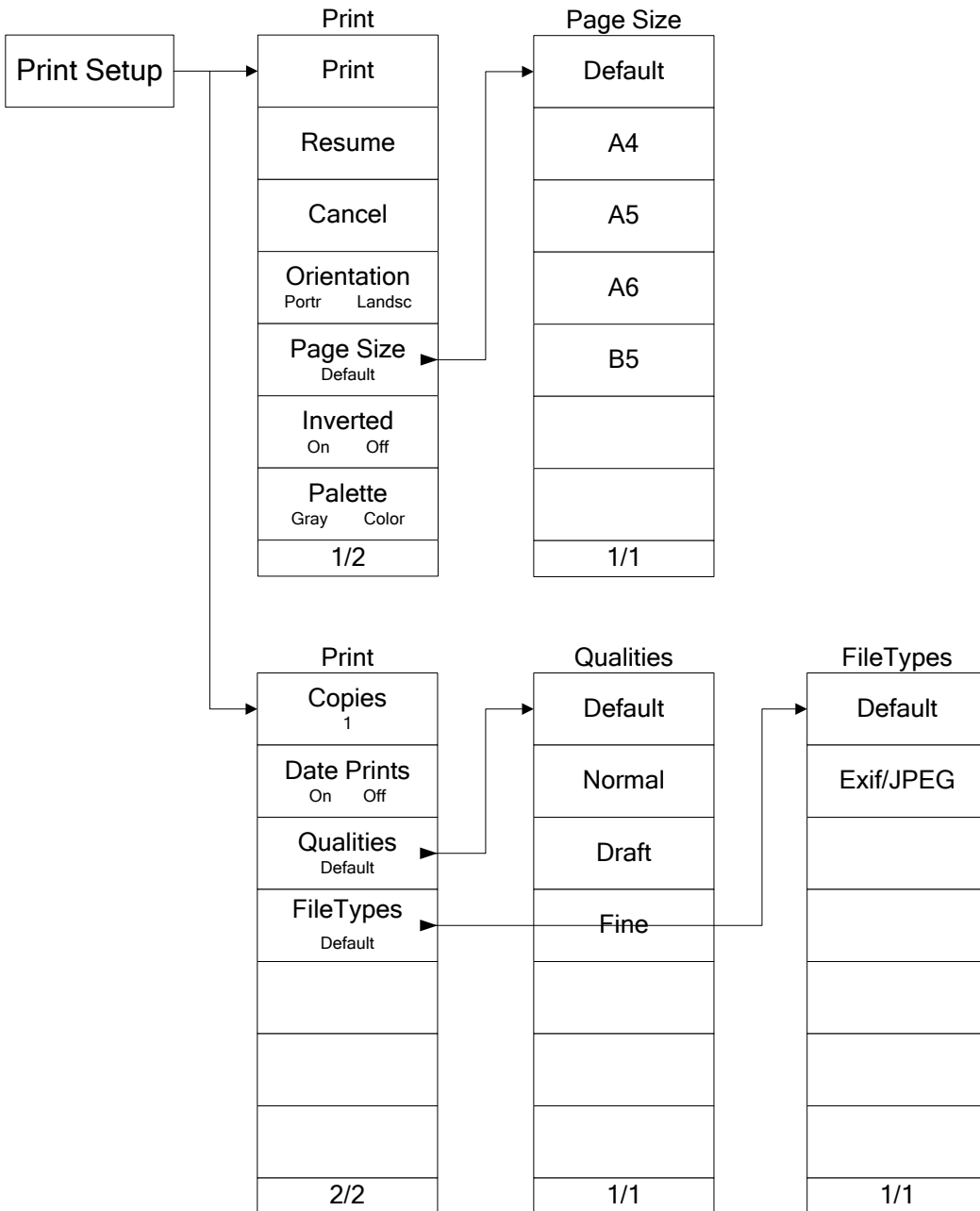

SPAN

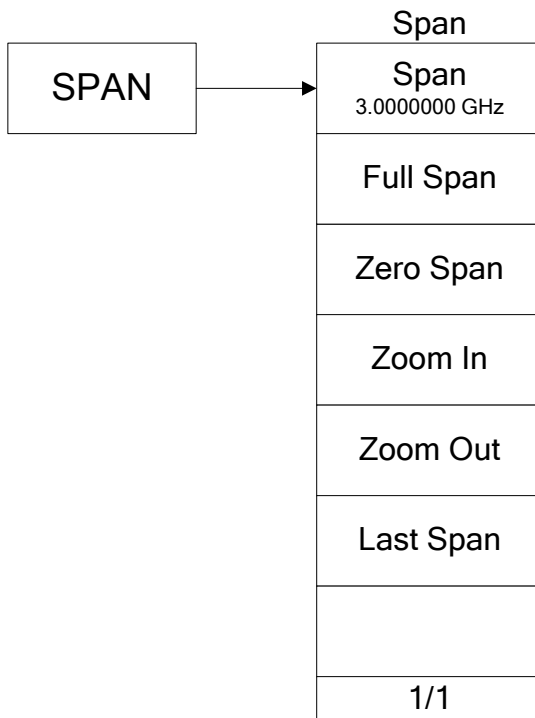

Storage

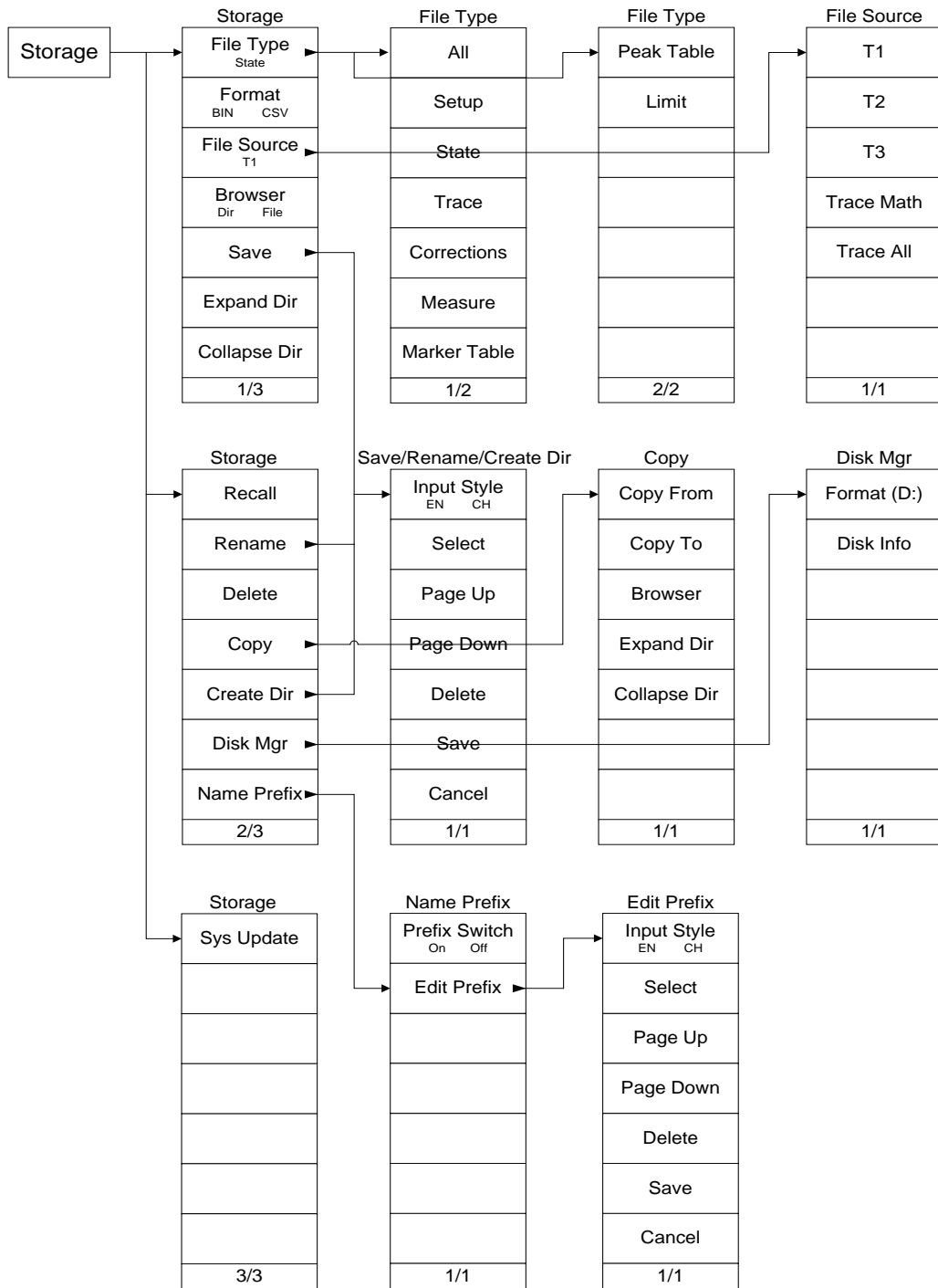

Sweep

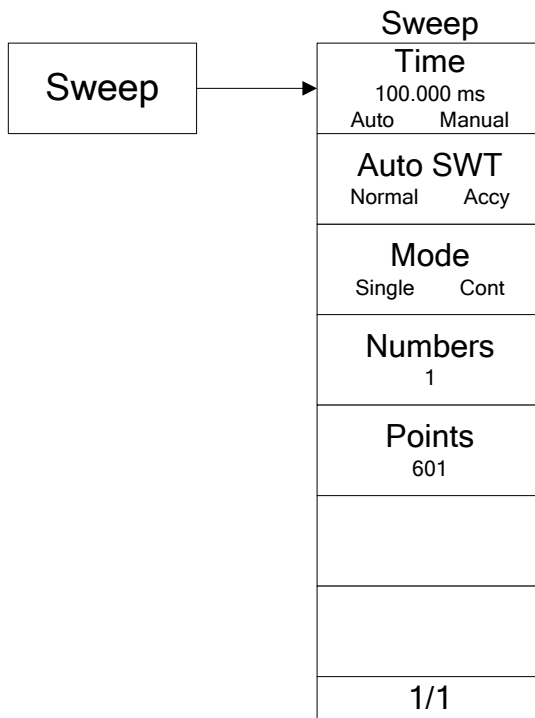

System

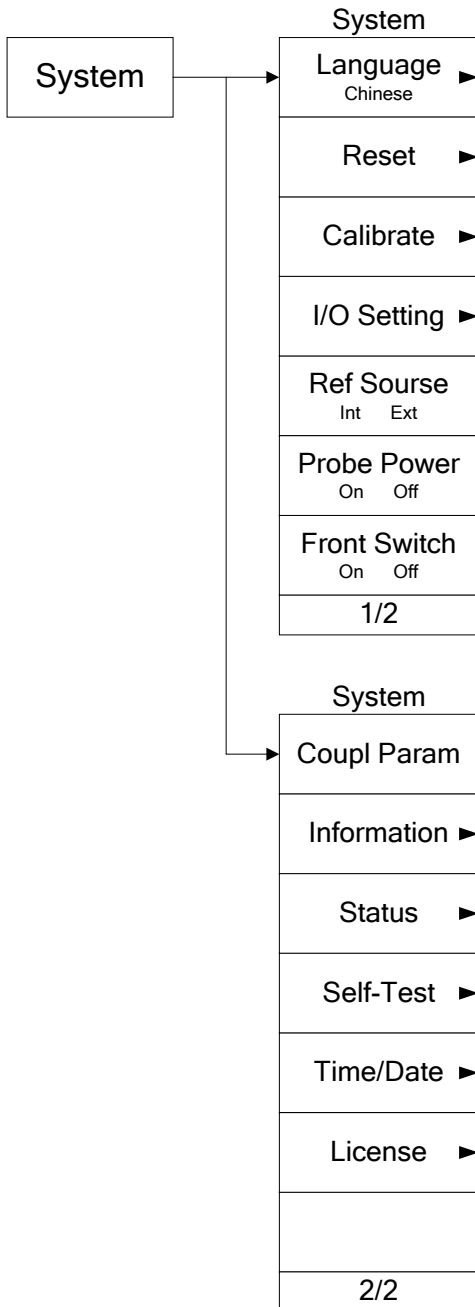

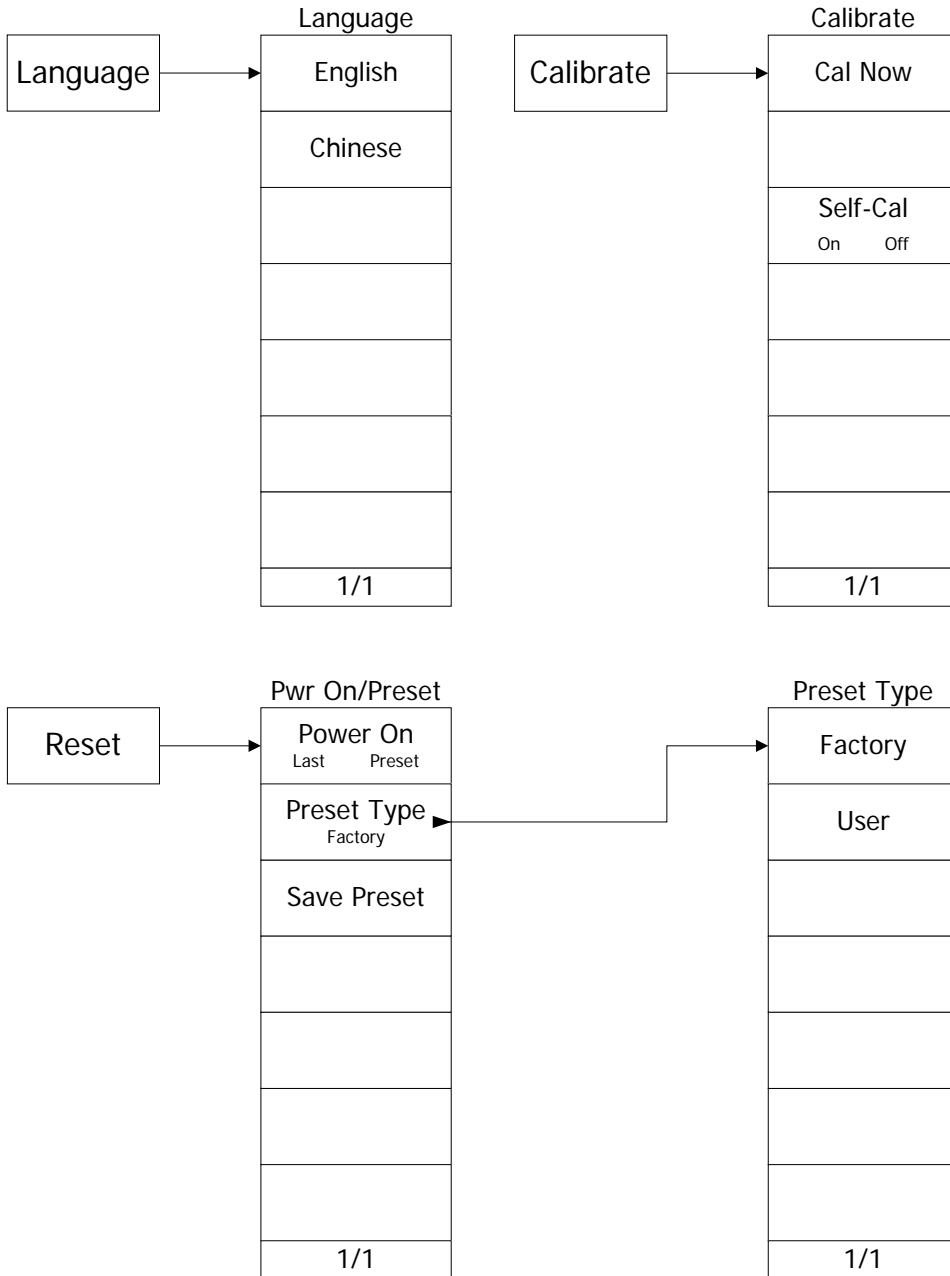

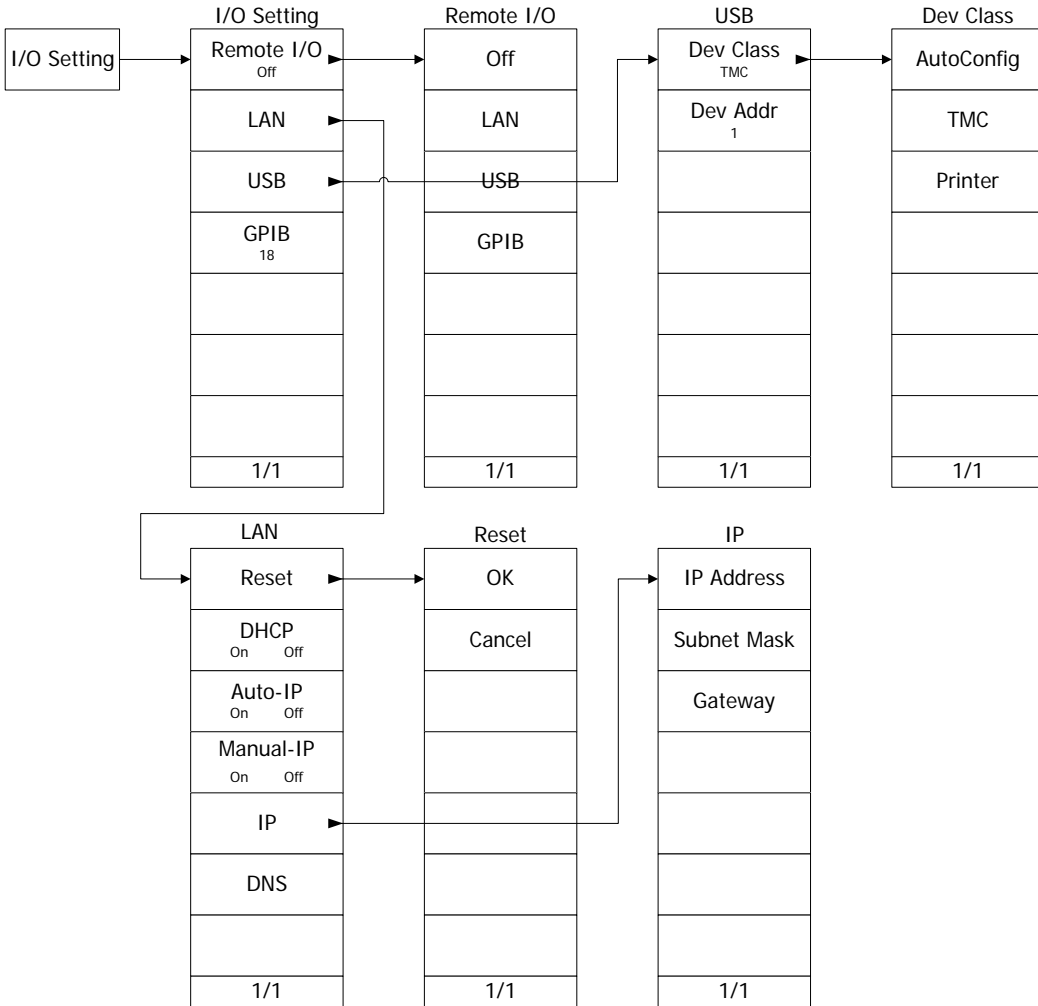

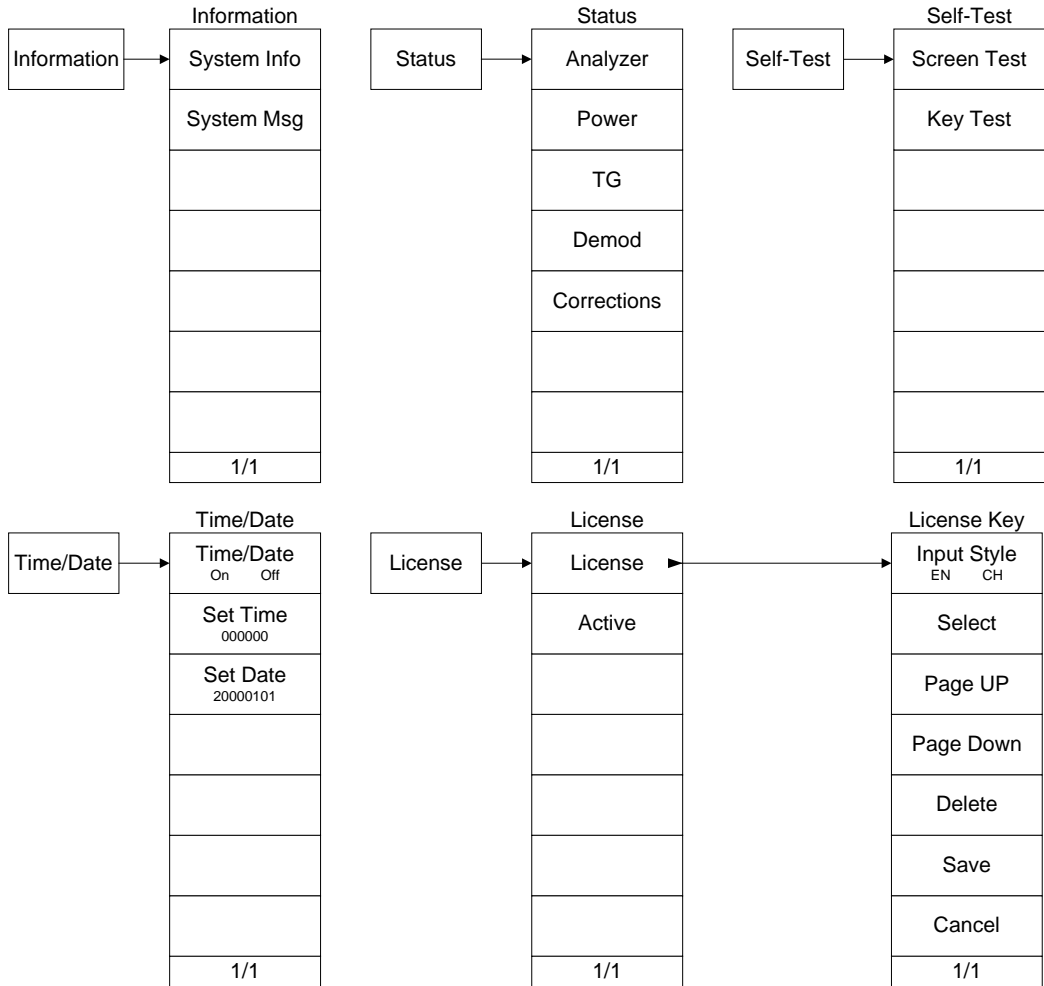

Source (DSA1030A-TG)

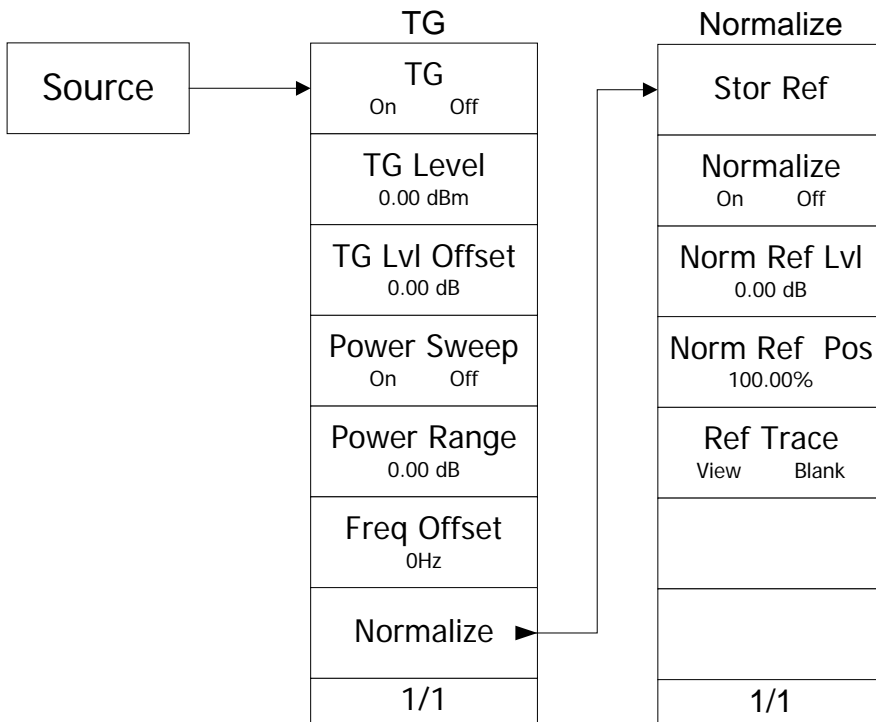

Trace

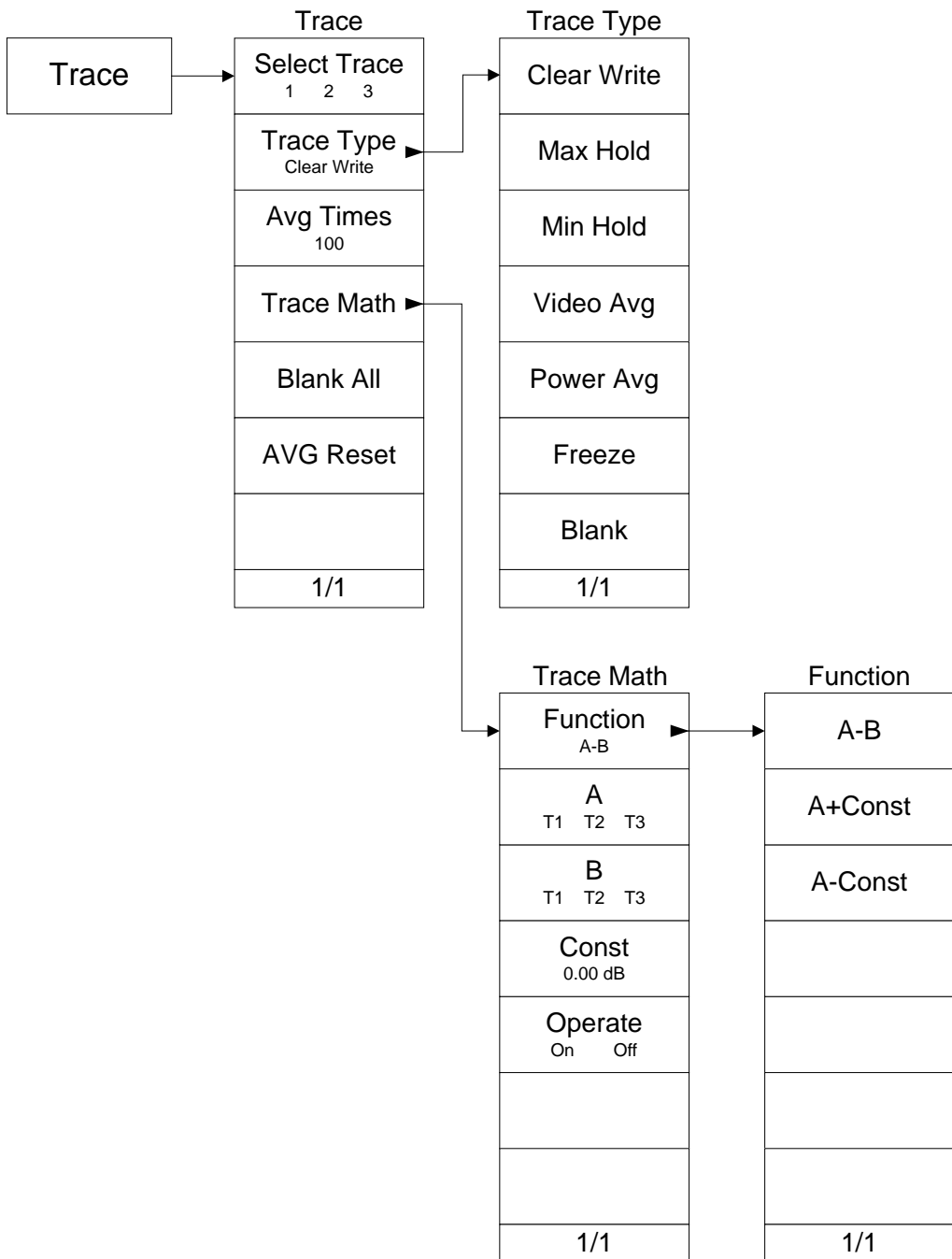

Trig

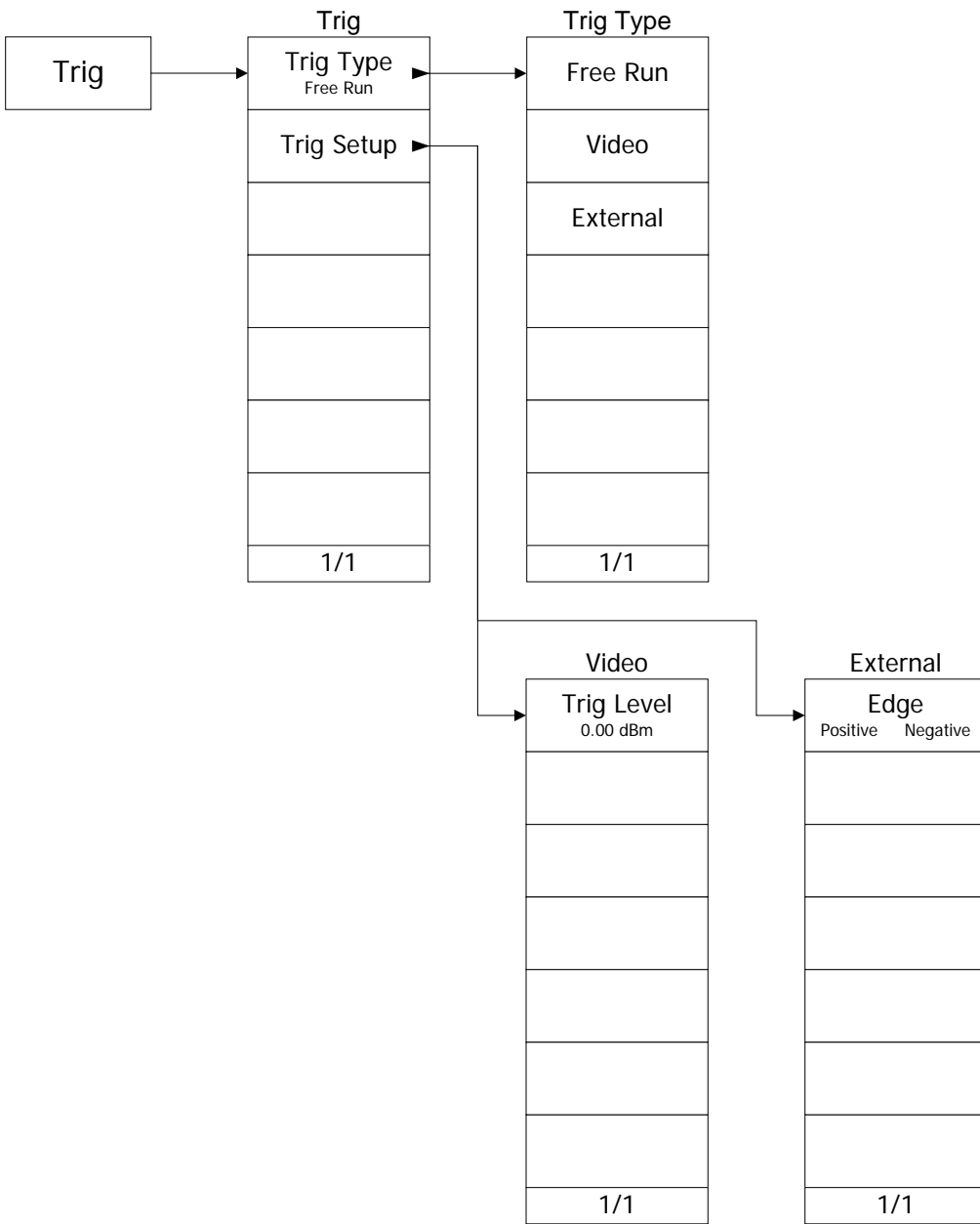

Chapter 8 Appendix

Appendix A: Ordering Information

	Description	Order Number
Model	Spectrum Analyzer, 9 kHz to 3 GHz, with preamplifier	DSA1030A
	Spectrum Analyzer, 9 kHz to 3 GHz, with preamplifier and tracking generator	DSA1030A-TG
	Spectrum Analyzer, 9 kHz to 3 GHz	DSA1030*
	Spectrum Analyzer, 9 kHz to 3 GHz, with preamplifier	DSA1030-TG*
Standard Accessories	Front Panel Protective Cover	FPCS-DSA1000
	Quick Guide (Hard Copy)	-
	CDROM (User's Guide, Programming Guide)	-
	USB Cable	-
	Power Cable	-
Options	Preamplifier (applicable to DSA1030 and DSA1030-TG)	PA-DSA1030
	Advanced Measurement Module (applicable to DSA1030 and DSA1030-TG)	AMK-DSA1000
	DSA PC Software	Ultra Spectrum
Optional Accessories	Include: N-SMA Cable, BNC-BNC Cable, N-BNC Adaptor, N-SMA Adaptor, 75Ω-to-50Ω Adaptor, 900MHz/1.8GHz Antenna, 2.4GHz Antenna	DSA Utility Kit
	Include: N(F)-N(F) Adaptor (1pcs), N(M)-N(M) Adaptor (1pcs), N(M)-SMA(F) Adaptor (2pcs), N(M)-BNC(F) Adaptor (2pcs), SMA(F)-SMA(F) Adaptor (1pcs), SMA(M)-SMA(M) Adaptor (1pcs), BNC T Type Adaptor (1pcs), 50Ω SMA Load (1pcs), 50Ω Impedance Adaptor (1pcs)	RF Adaptor Kit
	Include: 50Ω to 75Ω Adaptor (2pcs)	RF CATV Kit
	Include: 6dB Attenuator (1pcs), 10dB Attenuator (2pcs)	RF Attenuator Kit
	30dB High Power Attenuator, Max Power 100W	ATT03301H

N(M)-N(M) RF Cable	CB-NM-NM-75-L-1 2G
N(M)-SMA(M) RF Cable	CB-NM-SMAM-75-L -12G
RF Demo Kit (Transmitter)	TX1000
RF Demo Kit (Receiver)	RX1000
VSWR Bridge, 1 MHz to 2 GHz	VB1020
VSWR Bridge, 800 MHz to 4 GHz	VB1040
Rack Mount Kit	RM-DSA1000
Soft Carrying Bag	BAG-DSA1000
USB to GPIB Interface Converter	USB-GPIB
11.1 V, 147 Wh Lithium Battery	BAT (China Only)
Supporting Arm	ARM

Note*: For more details about DSA1000 series spectrum analyzer, please refer to *DSA1000 Series Spectrum Analyzer User's Guide*.

Appendix B: Warranty

RIGOL warrants that its products mainframe and accessories will be free from defects in materials and workmanship within the warranty period.

If a product is proven to be defective within the respective period, **RIGOL** guarantees the free replacement or repair of products which are approved defective. To get repair service, please contact with your nearest **RIGOL** sales and service office.

RIGOL does not provide any other warranty items except the one being provided by this summary and the warranty statement. The warranty items include but not being subjected to the hint guarantee items related to tradable characteristic and any particular purpose. **RIGOL** will not take any responsibility in cases regarding to indirect, particular and ensuing damage.

Appendix C: General Care and Cleaning

General Care:

Do not store or leave the instrument where it may be exposed to direct sunlight for long periods of time.

Cleaning:

Clean the instrument regularly according to its operating conditions. To clean the exterior surface, perform the following steps:

1. Disconnect the instrument from all power sources.
2. Clean the loose dust on the outside of the instrument with a lint-free cloth (with a mild detergent or water). When cleaning the LCD, take care to avoid scarifying it.



CAUTION

To avoid damage to the instrument, do not expose it to caustic liquids.



WARNING

To avoid injury resulting from short circuit, make sure the instrument is completely dry before reconnecting to a power source.

Index

1/ Δ Time	2-81	DANL	IX
ACP	2-48	Del Limit.....	2-75
Active Fct	2-101	Delta	2-78
Adj CH BW	2-55	Delta Pair	2-79
Analyzer.....	2-98	Demod	2-41, 2-98
attenuator.....	1-3	Demod Time.....	2-41
Auto Range	2-16	Disc Mgr	2-115
Auto Scale.....	2-11	Disk Info	2-115
Auto SWT	2-24	Display Line	2-101
Average	2-52	EBW	2-49
Average Times	2-38	Edge	2-30
Avg Mode.....	2-52	Edit.....	2-115
Avg Num.....	2-51	Edit.....	2-74
AVG Reset.....	2-40	EMI filter	2-23
Brightness.....	2-103	Expand Dir.....	2-113
C/N Ratio	2-49	External Reference	2-96
Cal Now	2-94	External Trigger.....	2-29
Carrier BW	2-68	Factory Default.....	2-105
Carrier Pwr.....	2-66	Fail Stop.....	2-75
Center Freq.....	2-2	File Source.....	2-113
CF -> Step	2-8	Format (D:)	2-115
CF Step.....	2-5	Free Run Trigger	2-29
CH Pwr	2-54	Freeze.....	2-38
Ch Pwr Span	2-58	Freq Count	2-87
CH Spacing	2-56	Freq Interp.....	2-18
Channel Power	2-48, 2-57	Freq Interp.....	2-75
Cleaning	8-4	Freq Offset	2-45
Clear Write.....	2-37	Frequency Range	IX
Coliapse Dir.....	2-113	Front Switch	2-96
Cont Peak	2-89	Full Span	2-10
Corr Table	2-19	Function.....	2-39
Corr View.....	2-19	GPIB	2-95
Correction.....	2-18	Graticule.....	2-102
Corrections.....	2-98	Harmo Dist	2-49
Coupl Param.....	2-96	Harmonics	2-70

Input.....	2-20	Peak Left.....	2-88
Input Atten.....	2-12	Peak Peak.....	2-89
Integ BW.....	2-58	Peak Right.....	2-88
Internal Reference.....	2-96	Peak Search.....	2-90
Key Test.....	2-98	Peak Sort.....	2-91
LAN.....	2-94	Peak Table.....	2-91
Last Span.....	2-10	Phase Noise.....	IX
Limit.....	2-74	PK Excursn.....	2-89
Main CH BW.....	2-55	Pk Readout.....	2-91
Marker Table.....	2-81	PK Thresh.....	2-90
Max Hold.....	2-37, 2-61, 2-64	Pos Peak.....	2-34
MaxMixL.....	2-19	Power Avg.....	2-38
Meas Mode.....	2-50	Power On.....	2-93
Menu Hold.....	2-102	Power Range.....	2-45
Min Hold.....	2-38	Power Ratio.....	2-62
Min Search.....	2-89	Power Spectral Density.....	2-57
Mkr Trace.....	2-80	Power Sweep.....	2-44
Mkr->CF.....	2-83	Prefix Switch.....	2-115
Mkr->Ref.....	2-84	Preset Type.....	2-93
Mkr->Start.....	2-83	Probe Power.....	2-96
Mkr->Step.....	2-83	Quasi-Peak.....	2-36
Mkr->Stop.....	2-84	RBW.....	2-21
Mkr Δ ->CF.....	2-84	RBW.....	1-3
Mkr Δ ->Span.....	2-84	RBW filter.....	2-23
Msg Switch.....	2-104	Ref Level.....	2-12
N dB BW.....	2-85	Ref Offset.....	2-15
Neg Peak.....	2-34	Ref Trace.....	2-47
Next Peak.....	2-88	reference level.....	1-3
Noise BW.....	2-67	Reset.....	2-93
Noise Mkr.....	2-85	RF Preamp.....	2-17
Norm Ref Pos.....	2-46	RMS.....	2-52
Normal.....	2-34, 2-78	RMS Avg.....	2-35
Normalize.....	2-46	Sample.....	2-34
OBW.....	2-49	Save Preset.....	2-93
Offset Freq.....	2-67	Scale Type.....	2-14
Pass/Fail.....	2-50	Scale/Div.....	2-13
Peak -> CF.....	2-7	Scr Saver.....	2-102

Scr State.....	2-102	Test	2-74
Screen Test	2-98	TG	2-98
Search Para.....	2-89	TG level.....	2-43
Self-Cal	2-94	TG Level Offset	2-43
Signal Track.....	2-6	Time	2-24
Skin.....	2-103	Time/Date	2-99
Source.....	2-43	TOI	2-49
span.....	1-3	TP Type.....	2-52
Span.....	2-61, 2-64, 2-73	T-Power.....	2-48
Span.....	2-9	Tracking Generator	IX
Span Pair	2-79	Trigger Level.....	2-29
Speaker	2-41	Units	2-14
Start Freq	2-3	USB	2-95
Start Line	2-52	V/R Ratio.....	2-22
Stop Freq	2-4	VBW	2-21
Stop Line	2-53	VBW	1-3
Stor Ref	2-46	Video Avg.....	2-38
Sweep Mode	2-25	Video Trigger	2-29
Sweep Numbers	2-25	Voltage Avg	2-35
Sweep Points.....	2-25	Volume.....	2-41
Sweep Time	2-70	X Axis.....	2-75
System Information.....	2-97	X dB.....	2-65
System Message	2-98	Zero Span.....	2-10